

Photoniques

THE MAGAZINE OF THE FRENCH OPTICAL SOCIETY

Special EOS Issue · March-April 2018

INSIGHT

Marketing for
the photonics industry

PORTRAIT

James Clerk Maxwell



BACK TO BASICS

Photonic crystals and
metamaterials

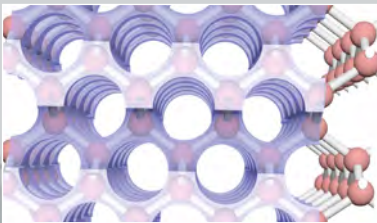

BUYERS GUIDE

A teraHertz (THz) camera

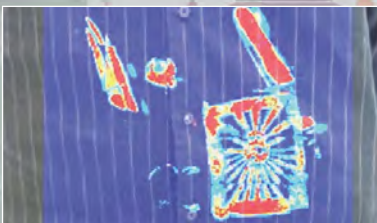

France/EU: 19€ - Rest of the world: 25€

www.photoniques.com

PHOTONICS IN EUROPE

special EOS issue



LASER COMPONENTS is unique!

Manufacturer ▪ Distributor ▪ Partner

Contact us!



small components
MASSIVE IMPACT

- Photodiodes
- IR Components
- Photon Counters
- Lasers
- Measurement Devices
- Fiber Optics
- Optical Components
- Machine Vision
- Laser Safety
- Laser Spare Parts



lasercomponents.fr

LASER COMPONENTS S.A.S.
45 Bis Route des Gardes
92190 Meudon

info@lasercomponents.fr
Tel: +33 1 3959 5225
www.lasercomponents.fr

Innovation, the heart of the reactor

Europe has a long-lasting tradition of technological competitiveness. As such, it lives from its knowledge and know-how. Innovation in photonics is one of the drivers of this competitiveness, producing knowledge and science, and transforming them into devices and applied systems.

But knowledge and know-how may not be enough: we must also make-knowing.

It is therefore not surprising that Photoniques' editorial committee dedicates this special issue to innovation through an overview of photonic devices and applications - that is innovation that hatches devices and makes them pass from the R&D laboratory to the industrial object, whether they are elementary components or complex systems. And then, besides a portrait of James Clerk Maxwell and a paper on the history of crystals and metamaterials, you will also discover an article dedicated to marketing for the photonics industry.



Riad HAIDAR
Editor-in-chief

Bonne lecture!

TABLE OF CONTENTS Special EOS Issue, March-April 2018

■ EOS/SFO FOREWORDS	2
■ SFO EVENTS	3
■ EOS NEWS	4
■ CLUSTER INFO	5
■ GLOBAL NEWS	10
■ PORTRAIT Famous optician: James Clerk Maxwell	16
■ INSIGHT - MARKETING & STRATEGY	
Marketing for the photonics industry	19
■ FOCUS: PHOTONIC DEVICES AND APPLICATIONS	
How can attosecond pulse train interferometry interrogate electron dynamics?	28
Lighting: a driver of the sustainable revolution	36
Gold nanoparticles as nanosources of heat	42
Retinal prosthesis system: a revolutionary advancement for the severely visually impaired	48
■ TECHNICAL NOTEBOOK	
Back to basics. History of photonic crystals and metamaterials	50
■ PRODUCTS	
Buyer's guide. Terahertz (THz) cameras	58
New products	62



Photo credit (cover): © iStockPhoto

Dear SFO and EOS Members,

This issue of *Photoniques*, the periodic journal and newsletter of Société Française d'Optique (SFO) is published entirely in English as a special service to all EOS members. This is the second issue of this kind. The EOS Board is very happy with this initiative as it strengthens the ties between the EOS and its branches.

The fact that the EOS is a federation of many active national optics and photonics societies is a strength that is particular to EOS. Many of these national societies have a long and impressive tradition on their own of serving the optics and photonics scientific community. EOS can and should profit from these traditions more than has happened in the past. Many of the bigger national societies organize quite successful meetings with many attendees. It may be an interesting option for some of our national societies to once every few years make their event an official EOS event and thereby increase its international impact. This would require that on these occasions English will be used as language.

The initiative of SFO and EOS to publish yearly an issue of the journal *Photoniques* as a service to the entire EOS community is a good example of a closer collaboration between EOS and its national societies and the EOS hopes that it will boost the collaboration with other national societies.

As you probably know, the bi-annual meeting of EOS (EOSAM2018) will be held in Delft from 9-12 October 2018. You can submit an oral or poster presentation in nine topical meetings which together cover a broad area of optics, from fundamental to industrial. On Monday 8 October, the day before the conference starts, there will be tutorials for students where the main topics of the conference are introduced. Furthermore, as on previous occasions, a session intended for the dissemination of EU research projects in the field of optics will be organized. A project for dissemination can be submitted on the EOSAM2018 website. The very successful Grand Challenges Session will be held again and the Zeiss student prizes for best poster and best oral presentations will be handed out. Last but not least, an industrial exhibition will be held in parallel to the conference. As is tradition during EOS meetings, several networking events will be organized, in particular the conference dinner on Thursday evening in the Royal Delft Pottery Factory and Museum (established in 1653). We hope to see many of you in Delft!

Paul Urbach,
President of EOS



Paul URBACH



Pascale NOUCHI

After the success of the first edition of *Photoniques* in English, we are very proud to present this second edition. *Photoniques* is a periodic journal and newsletter for the members of the Société Française d'Optique (SFO) which comes out 5 times a year. SFO is a non-profit organization, gathering about 800 individual members, coming from both academia and industry, and 40 corporate members. We welcome student as well as professional members. We all know optics/photonics is a very broad and diverse field, covering a wide range of applications, and our organization really reflects this diversity. We are indeed organized through 20 "thematic clubs", each of them being focused on a dedicated topic, again, as varied as nanotechnology, guided optics, quantum technology and so on... Each of this club aims at bringing advances in its field and being the vector of technological innovation for various industries. Among their activities, there is the organization of scientific workshops bringing together the academic and industrial stakeholders of optics and photonics.

Every even year, SFO has its signature event, the congress "OPTIQUE", which is co-organized with and hosted by a French University, different each time. This congress gathers most of our "thematic clubs", and aims at fostering collaboration across the different fields of optics. This congress includes multiple sessions in parallel as well as several plenary sessions with renowned speakers in various field of optics. This year, our congress is hosted in Toulouse, after the success of OPTIQUE Bordeaux in 2016 with a record attendance of 590 participants. This edition in Toulouse will have a special flavor because Toulouse has been selected as the European City of Science, and as such, will host the 8th edition of ESOF (EuroScience Open Forum). OPTIQUE Toulouse will start July 3rd, for 4 full days. We feel very lucky to welcome Alain Brilliet for the opening plenary. Alain Brilliet was awarded the CNRS 2017 Gold medal for his major contributions to the detection of gravitational waves.

I truly hope you will enjoy reading this special *Photoniques* issue.

Pascale Nouchi
President of SFO

OPTIQUE Toulouse 2018 ESOF 2018 satellite event



From July 3 to 6, 2018, Toulouse will host the major congress of the French Optics Society (SFO) which brings together, every two years, the national optics community by proposing themes as varied as lasers, quantum optics, guided optics, adaptive optics, crystals for optics, organic photonics, optical diagnostics...

This major congress, hosted on the site of the Toulouse III-Paul Sabatier University, will thus be an opportunity to federate the various branches of optics in France through several plenary conferences of guest

speakers, associated to many thematic conferences and posters sessions conducive to discussions. In addition to the scientific presentations, a session devoted to relations with the industrial world and a pedagogical session will also offer the opportunity for numerous exchanges between the expected 650 attendees.

On the other hand, it should be noted that for the second consecutive edition, our congress will also host the PAMO (Atomic, Molecular and Optical Physics) conference of the French Society of Physics (SFP).

OPTIQUE Toulouse 2018 in a few figures

- 7th edition of this biennial congress
- 11 SFO thematic clubs represented (including 4 for the first time)
- 650 expected attendees
- 7 hours of plenary session
- 70 hours of specific sessions in parallel
- 5h30 dedicated to the industrial sector
- 40 stands of companies in the ecosystem of optics and French photonics

READ MORE:

www.sfoptique.org/pages/congres-optique/optique-toulouse-2018/

SFO international thematic schools



In 1987, Pierre Chavel initiated the SFO thematic schools taking place in Les Houches School of Physics. It was then a great and much-appreciated

opportunity for young researchers to learn about the latest developments in emerging fields of optics and photonics.

The SFO wants to keep this tradition vivid through the organization of thematic schools held every year in order to provide high-level training accessible to a doctoral student audience. They will be international and open to any nationality. A different topic will be highlighted each year, addressing a subject requiring a 'back-to-basics' approach, or an emerging theme

where fundamental concepts have to be solidified.

The first school of this new series, "Excitonics for photonic applications", will take place in Les Houches School of Physics from April 16 to 27, 2018. It will interrogate the basic and unifying concepts behind opto-electronic devices based on organic semiconductors, hybrid perovskites or colloidal quantum dots.

The 2019 School will be about High-precision physics using disseminated optical frequency references and optical frequency combs.

Women in Physics committee, to promote gender fairness in Optics

There is now a group within the French Optical Society (SFO) whose ambition is to increase the visibility of women in Optics and to improve their position in Optics research in academics as well as in private companies, in order to attract more numerous young women in Optics research. This new committee shares experience and interest with the elder French Physical Society (SFP)'s committee:

1. They proposed actions to actively promote fair recognition for women in scientific conferences, gathered in the charter to conference organizers applying for any help of SFO (label, funding or communication action), signed by SFO, SFP, Women in Sciences French Association and CNRS.

2. They took part together for the first time to the IUPAP International Conference on Women in Physics in Birmingham in 2017.
3. The charter for gender fairness has been fruitfully applied to organize the next SFO congress taking place in Toulouse in 2018.

By promoting Women in Science and encouraging actions toward this objective, the French Optical Society hopes to attract more and more young people, men and women, in the various careers related to Optics.

WEBPAGE OF THE COMMITTEE :

<http://www.sfoptique.org/pages/les-clubs-sfo/commission-femmes-et-physique/>

Terahertz Science & Technology - TST 2018

European Optical Society organizes the 6th Topical Meeting on Terahertz Science & Technology (TST 2018) in Berlin, Germany, between 6th and 9th of May, 2018. The topical meeting will gather around 100 participants from Europe and all over the world to Radisson BLU Hotel, located in the heart of Berlin, between 6th and 9th of May, 2018.

The chairs of the conference are Prof. Heinz-Wilhelm Hübers from German



Aerospace Center (Germany) and Dr. Jozsef Fülöp from University of Pecs (Hungary). The topical meeting provides a platform on which the latest results in the generation, detection and use of THz radiation in science and technology will be presented and discussed.

www.myeos.org/events/tst2018

Topical Meeting on Waves in Complex Photonics Media

The Topical Meeting on Waves in Complex Photonics Media: Fundamentals and Device Applications will be held for the first time, in the beautiful scenery of Italy, Anacapri, in the Island of Capri between 4th and 7th of June, 2018. A long list of world-renowned experts in the field of optics in complex

media have been invited to speak at the event. The meeting is chaired by Luca Dal Negro, Boston University (USA), and Vito Mocella, Consiglio Nazionale delle Ricerche (Italy). Read more about the meeting and check out the list of speakers and topics on the EOS website: www.myeos.org/events/anacapri2018

EOS Biennial Meeting (EOSAM) 2018



EOS biennial Meeting will be held in Delft, Netherlands, at the high-end facilities of the Delft University of Technology, in October 8 - 12, 2018. Netherlands is the hot spot for photonics in Europe and the strong optics research and industry in Delft makes it a perfect location to hold the symposium. EOSAM includes several topical meetings, tutorials, workshops, industrial exhibition, and more.

The Topical Meetings (TOMs) include:

- TOM 1- Silicon Photonics and Guided-Wave Optics
- TOM 2- Freeform Optics for Illumination,

- Augmented Reality and Virtual Reality
- TOM 3- Optical System Design, Tolerancing, and Manufacturing
- TOM 4- Bio-Medical Optics
- TOM 5- Metamaterials, Plasmonics and Resonant Nanophotonics
- TOM 6- Frontiers in Optical Metrology
- TOM 7- Organic & Hybrid Semiconductor Materials and Devices
- TOM 8- Adaptive Optics & Information driven optical systems
- TOM 9- Optical tapered fibers for light manipulation on the nanoscale - NEW

On top of the topical meetings, EOSAM includes the already established sessions on EU Project result dissemination, and the Grand Challenges of Photonics. In this session, world-class speakers will discuss technologies which are revolutionary, uncommon and not realizable to date, but can pave the way for an even brighter future in optics and photonics. Prior to the actual conference program,

tutorials and autumn physics school are organized at the conference venue on Monday 8 October. Tutorials will cover topics of the Topical Meetings. The Autumn Physics School on Metrology for Thin Film Materials is also held on Monday 8 October, parallel to the tutorials. The school is organized as part of dissemination activity for the Project 16ENG03 HYMet: <https://www.hymet.ptb.eu/> Industrial attendees are also not forgotten in the event. The two-day industrial exhibition will once again be held alongside the conference program during the week. Companies are invited to send industrial posters to Topical Meeting (TOM) 3 on Optical System Design, Tolerancing, and Manufacturing. There are also other exciting things planned, among others, a "Meet and Greet" for companies and students.

More information on the event website: www.myeos.org/events/eosam2018

EOS Fellow nomination

As every year, all members of the EOS are invited to nominate up to three other members for the distinction of EOS Fellow. All nomination forms and supporting material must be received by August 1, 2018. The Fellows will be honoured with the official diplomas at the Annual General Assembly in Delft, Netherlands, in collocation with EOSAM2018 symposium, during October 8-12, 2018.



SAVE THE DATE

EOS Optical Technologies at the World of Photonics Congress

June 23-27, 2019

<http://www.myeos.org/events/wpc2019>

Nextpho21, a project to grow and coordinate the European photonics industry

The current photonics industrial strategies are focusing on technologies needed for current markets whereas successful strategies for the future should forecast the potential growth of *new* markets. In order to drive the industrial revolution instead of reacting to it, the European photonics community, companies and research organizations alike, **need to change the way strategies are developed and implemented**. NextPho21 will provide the decisive organizational and strategic support to the Photonics21 community to conduct this radical process. The “#next_Photonics” strategy will pave the way for European photonics community to drive the next industrial revolution.

NextPho21 focuses on five key objectives:

1. to support the development of a European Industrial Photonics Strategy for 2021-2028;
2. to support the implementation of the Horizon 2020 Photonics Public Private Partnership (PPP);
3. to re-inforce and build up new value chains between photonics and end-user industry;
4. to increase access to finance for photonics start-ups and SMEs to commercialize photonics innovations;
5. to initiate and coordinate cross-national and cross-regional public investments in photonics.

Photonics France is in charge of coordinating substantial progress in aligning European, national and regional public funding actions to further initiate and integrate common activities on photonics in Europe. It will provide support to establish permanent cross-member and cross regional research and innovation investments projects in photonics. Photonics France will also be in charge of organizing workshops in photonics throughout the project: the first one will probably be on medical and life market and the second one on agriculture and food industry.

Merging AFOP and CNOP to become the new association “Photonics France”

The French Manufacturers Association for Optics and Photonics, AFOP and the French Committee of Optics and Photonics, CNOP have decided to merge to create Photonics France, the French Federation of Photonics. The merge will be held on 24th April in Strasbourg. The aims of Photonics France are:

1. to lead and develop a promising sector based on the photonics technology;
2. to promote technological solutions and innovative capacities provided by photonics technology;
3. to represent, coordinate and support French photonics industry.

The members of Photonics France are more than 120 French industrials, academics and clusters who represent the national skills in photonics.

Photonics France can rely on its 120 years of experience in representing, promoting and defending the interests of its members, providing efficient services, national and worldwide visibility, while having government support.

CONTACT : www.photonics-france.org - contact@photonics-france.org

Roadmap of the French Photonics

The French industry of photonics has decided to prepare and present its roadmap of Photonics in France.

The aims of this roadmap are:

- to identify the needs of photonics functions and technologies;
- do the state of art and roadmaps of the photonics technologies in 5 years;
- to propose actions and projects with the French industry of photonics to develop these technologies;
- to prioritize and promote the roadmap to the French and European authorities to get funds.

The roadmap will be published in French in April 2018 and will be presented during the day of Photonics at the French Ministry of Economics on 4th June, 2018.

New members 2018: a large representation of photonics' French know-how

AFOP has started 2018 with more than 100 members. For the last three months, the Council has increased its membership by 10. The optic-photonics professional association shows, once again, its dynamism as well as benefits that companies can gain by joining it.

In addition to many services offered – watches, networking, press and trade fair partnerships, purchasing center... – we are currently establishing the French photonic roadmap.

If your company is based in France (head office, subsidiary...) and you are interested in joining us, don't delay, contact us!



BiOS and Photonics West 2018: strong presence from the ALPHA-RLH cluster and its members

The international trade fairs BiOS and Photonics West were held in San Francisco from 27 January to 1 February 2018, bringing together actors in photonics, lasers and biomedical optics from around the world.

The ALPHA-RLH cluster attended the two fairs with ten of its member-companies: I2S, ISP System, Le Verre Fluoré, Neta, Scoptique, Spark Lasers, Amplitude Systèmes, ALPhANOV, Femto Easy and Iriosome Solutions. New spectroscopy and imaging methods

were presented at the event, in particular the ASOPS spectroscopy method by Neta, I2S's Terahertz camera and Spark Lasers' laser for health applications.

Alongside the Photonics West fair, SPIE and the French Tech Hub ran the Photonics Fast Pitch, where ten companies pitched their fundraising projects in two minutes. France was represented by two companies from Nouvelle-Aquitaine: ALPhANOV and their product, GoSpectro, and Femto Easy with their innovative

range of products for ultrafast laser measurements, who were able to meet manufacturers and potential investors.



ESCP-4i label for ALPHA-RLH and its European partners in the "Clusters Go International" call

On February 20th, in Brussels, ALPHA-RLH took part to a launch event organized by the European Commission with all 23 recipients of the "Clusters Go International" call among which France has performed very well with 18 partners involved.



On February 21st, the PIMAP Partnership led by ALPHA-RLH (France) and its 3 European cluster partners: Triple steelx (Sweden), Joesnuu SP (Finland) and Produtech (Portugal), gathering 900 SMEs, received the European Strategic Cluster Partnership - Going International (ESCP-4i) Label from Antti Peltomäki, Deputy Director General @ DG GROW (European Commission).

The PIMAP objective is to develop economic activity and boost innovative SMEs' growth at international level for photonics industry applications through interclustering matchmaking

events, the integration of high tech in the manufacturing and smart factory industries and their related applications. The kick-off meeting of PIMAP project was held on March 19 in Brussels.

Thanks to the ECCP (European Cluster Collaboration Platform) for its highly valuable support and for the organization on February 22nd of a Matchmaking Event to foster networking between European clusters. ALPHA-RLH met with 6 potential partners for future initiatives: France, Germany, Romania, Spain, Sweden and the European Japan Center.

The European project IT-ELLI will be presented during SPIE Photonics Europe

IT-ELLI is a European partnership program dedicated to training in optics, photonics and lasers based on 3D virtual and augmented reality.

PYLA, training center for the ALPHA-RLH cluster, coordinates this project and will provide demonstrations on the 3D virtual lab. Visit us on SPIE Photonics Europe on 24-25 April 2018: European Village, booth EN4.

Launch of the new ECEI label policy

The ALPHA-RLH cluster, which presides over the Europe Committee of the AFPC (Competitiveness and Business Clusters Organization), participated in the launch meeting for the new ECEI 2.0 (European Cluster Excellence Initiative) label policy on February 1, 2018, in Berlin. This involved establishing a new methodology and a sustainable economic model of the system for awarding Bronze, Silver and Gold labels which recognize European clusters for their management quality.

INTERNATIONAL EVENTS

French Pavilion at Photonics Europe

– April 24-25, 2018 in Strasbourg (France) - Booth G204

Collaborative economic trip to Japan – May 7-11, 2018 in Tokyo and Hamamatsu (Japan)

International Microwave Symposium (IMS) – June 10-15, 2018 in Philadelphia (USA)

European Microwave Week (EuMW) – September 23-28, 2018 in Madrid (Spain)

INPHO Venture Summit October 11-12, 2018 in Bordeaux (France)

PHAROS EVENT – December 5-7, 2018 in Bordeaux (France)

Meet Photonics Bretagne and its members at Photonics Europe

Photonics France, the French trade association of photonics manufacturers, coordinates a French Pavilion at Photonics Europe - which will be held in Strasbourg, France, April 24-25, 2018, in cooperation with other photonics agencies (ALPHA-RLH, the Club Laser & Procédés (CLP), Minalogic

and Opticsvalley). This pavilion gathers about thirty companies, among which 11 Photonics Bretagne members: Bktel, Diafir, Evosens, IDIL, iXblue, Kerdry, Le Verre Fluoré, Leukos, Optinvent, Oxxius and SelenOptics.

Come visit us and discover the french photonics innovations: Booth G204.

Photon Lines and Diafir showcased 2 photonics demonstrators at CFIA exhibition

In "the Agri-food Factory of the Future" framework organized at CFIA exhibition (Carrefour des Fournisseurs de l'Industrie Agroalimentaire, held on March 13-15 in Rennes, Photon Lines and Diafir highlighted 2 examples of photonics use for agri-food applications. Under the broad "Safety on line" theme, those two demonstrators focused on food and process safety.

- Diafir and its DELBIA project partners (online detection of biocide for the food industry) including Photonics Bretagne, introduced an *in situ* water rinsing monitoring tool dedicated to production lines, which allows detection of biocide at very low concentrations. Line can be rinsed and production resumed in a time lapse of half an hour.
- Optical analysis solutions specialist Photon Lines, presented an on line quality control device which combines near-infrared spectral analysis technologies with intelligent vision. With the example of the potato chips, Photon Lines demonstrated that nutritional composition can be controlled directly on the production line, while simultaneously performing a visual appearance conformity control with the help of an artificial intelligence based machine vision system.

Photonics Bretagne welcomes a new engineer



RT team of Photonics Bretagne welcomes Adil Haboucha, a photonics and fibre systems specialized engineer. An ENSSAT graduate and R&D engineer at FOTON laboratory, he comes back to

Lannion after 2 years in Quebec at the Centre for Optics, Photonics and Lasers and 2 years in Rouen at CORIA where he worked as research scientist. His experience and expertise will serve the development of the fibre lasers and amplifiers capabilities, and the support for the fibre characterisation of the structure.

NEW MEMBERS

SEFG Innovation develops and sells an innovative system to boost the practice of surf sports (surfing, skiing...).

EA Optimag, optics and magnetism laboratory located at the UFR Sciences and Technology of Brest, result from the merger of the Laser Spectrometry and Optics Laboratory (LSOL) and the Magnetism Laboratory of Brittany (LMB).

TDM 360 specializes in virtual technologies and 360° imaging, and offers, through its VIP studio 360 brand, an innovative digital marketing solution for professionals from all sectors of activity.

BRO-SP is a lighting system design and engineering company.

Nemo Engineering is a study office where engineering and design are gathered to create and innovate.

Pôle Alpha-RLH is a photonics and microwaves competitiveness cluster in Nouvelle-Aquitaine.

The Foton Lab becomes the Foton institute



Under its new name, the Foton Institute brings together three laboratories (the DOP team located in the campus of the University of Rennes 1-Beaulieu, the OHM team at INSA-Rennes and the SP team at ENSSAT-Lannion) and three technological platforms (CCLO, Persyst, NanoRennes) to create an academic research centre in photonics in Brittany. Research is about photonic key enabling technologies, a top priority of Europe and Brittany.

MirSense raises 2 million € from Xange et Supernova

Founded by two researchers, Mathieu Carras and Mickael Brun, MirSense is specialized in lasers for the mid-infrared, specifically geared for spectrometry applications.

The company has designed a new generation of ultra-compact gas sensors for gas emissions monitoring, dangerous substances detection and biological samples analysis. The aim is to improve industrial processes and some mass-market products. The funds which were raised will allow new advances in gas detection miniaturization systems, and strengthening of the company's commercial development.

OPTITEC - Regional cluster with European vision & international ambitions

French photonics cluster OPTITEC federates more than 220 members and partners, including 130 innovative companies, covering the entire supply chain in the photonics and imaging sector with applications in the fields of Medical Technologies, Smart Cities, Industry 4.0 and Security & Defence.

Headquartered in Southern France, in Marseille, OPTITEC's main mission at regional and national level is to promote activities of the photonics sector in the Provence Alpes Côte d'Azur (Marseille, Nice, Cannes) and Occitanie (Toulouse, Montpellier, Nîmes) regions and to foster the synergies between its members from industry, research and higher education sectors.

As one of the leading European clusters, holding the prestigious Gold Label for cluster management excellence, OPTITEC fosters participation of its members in various EU R&D programmes, notably in Horizon 2020.

In 2014 OPTITEC consolidated its offer of services linked to the European R&D programmes by appointing a full-time European representative based in Brussels.

"Setting-up a permanent office in Brussels was a strategic decision for OPTITEC. As the capital of the European Union, Brussels is de facto a major decision-making centre regarding the R&D at European level. Our presence here allows us to daily interact with our European institutional and industry partners, thus accelerating international collaboration. Since opening the office in 2014, we have been able to secure more than 2,5 million € of Horizon 2020 funding for the innovation activities of the cluster and its members. And we're not stopping here!" said Mr Ziga Valic, Head of EU & International Affairs.

In order to enhance visibility and competitiveness of its members, OPTITEC facilitates interaction with the European partners of photonics and imaging through the EPRISE project involving clusters from Germany, the UK, the Netherlands, Italy, Sweden, Spain and Finland.

Find out more about Photonics cluster OPTITEC:

<http://www.pole-optitec.com/>

Success story: First Light Imaging & C-RED project

One of the supported SME members is First Light Imaging with its C-RED project, which was born in 2014, from the idea to create the fastest low noise infrared camera in the world. This ambitious and innovative project was funded by the European Commission as part of the SME Instrument in the framework of Horizon 2020.

C-RED One, together with its successor C-RED 2, is now commercially available and has been awarded the 2016 SPIE Prism Award in Imaging & Cameras category.

Read more about C-Red Project and First Light Imaging:

<https://www.first-light.fr/>

NEW BY OPTITEC !

**A new marketplace dedicated to photonics,
operated by French Cluster OPTITEC !**

Light2Share.com is an online platform offering access to **high technology equipment and expertise** in the fields of photonics and imaging

**Reduce costs and accelerate your R&D projects by
using Light2Share !**



light2share@pole-optitec.com
www.light2share.com



light2share
by optitec



Horizon 2020 project: EPRISE - Empowering Photonics through Regional Innovation Strategies in Europe

The EPRISE project, coordinated by OPTITEC, aims at promoting and supporting photonics as a Key Enabling Technology (KET) with a focus on Life Science applications in 4 target markets where Europe holds a leading position – Medical Technologies, Pharmaceuticals, Agriculture and Food.

Companies developing photonics-based products for these markets face highly specific Go to Market challenges such as long time-to-market adoption, complex regulatory frameworks and high barriers to market entry, to name only a few. SMEs or start-ups involved in these markets are often in need of support from public funding to help them cross the “Valley of death” between innovation ready phase (TRL 4), and investment ready phase (TRL 7). During this time, they are also in need of advice from

market specific experts who can guide them on non-technological topics.

A consortium of 9 partners from 8 European countries is tasked with the implementation of the project:

- OPTITEC (France, coordinator)
- Centre for Process Innovation (United Kingdom)
- OptecBB (Germany)
- Optoscana/Consiglio Nazionale delle Ricerche (Italy)
- Photonics Bretagne (France)
- Photonics Netherlands (The Netherlands)
- PhotonicSweden (Sweden)
- Photonics Finland (Finland)
- SECPHO (Spain)

The EPRISE consortium will organise the “European Photonics Roadshow”, a series of 7 major events hosted by

different European regions, with the aim of providing SMEs with concrete business solutions taught by market experts on how to overcome market barriers as well as of boosting collaboration along the complete value chain via pre-arranged B2B meetings.

European Photonics Roadshow calendar

- Florence: 16-17 May 2018
- Stockholm: 11-12 June 2018
- Barcelona: September 2018*
- Berlin: 17-18 October 2018
- Marseille: November 2018*
- The Netherlands: February 2019*
- Darlington: March 2019*

*Tentative dates

For further information about the project please visit <https://eprise.eu/>



OPTITEC, European cluster in photonics and imaging

Driving innovation in light in Southern France and across Europe!

CONTACT US FOR THE NEXT DATES !

17th to 21th June 2018 | Economic Mission to Singapour
6th to 8th November 2018 | Vision - Messe Stuttgart
8th to 11th January | CES 2019
5th to 7th February | Photonics West 2019

www.pole-optitec.com



The path length of light in opaque media

A seemingly paradoxical prediction in physics has now been confirmed in an experiment: no matter whether an object is opaque or transparent, the average length of the light's paths through the object is always the same.

What happens when light passes through a glass of milk? It enters the liquid, is scattered unpredictably at countless tiny particles and exits the glass again. This effect makes milk appear white. The specific paths that the incident light beam takes depend, however, on the opacity of the liquid: a transparent substance will allow the light to travel through on a straight line, in a turbid substance the light will be scattered numerous times, travelling on more complicated zig-zag trajectories. But astonishingly, the average total distance covered by the light inside the substance is always the same. Professor Stefan Rotter and his team (TU Wien, Austria) predicted this counter-intuitive result together with French colleagues three years ago. Now he and his collaborators from Paris verified this theory in an experiment.

Particles and waves

"We can get a simplified idea of this phenomenon when we imagine light as a stream of tiny particles", says Stefan Rotter. "The trajectories of the photons in the liquid depend on the number of obstacles they encounter." In a clear, completely transparent liquid, the particles travel along straight lines, until they leave the liquid on the opposite side. In an opaque liquid, however, the trajectories are more complicated. The beam of light is scattered frequently along its way, it changes its direction many times, and it can only reach the opposite side after covering a long distance inside the opaque substance. But in a turbid liquid, there are also many photons, which will never reach the opposite side. They do not completely traverse the liquid, but just penetrate a little below the surface and after a few scattering events they exit the liquid again, so their trajectories are rather short. "It can be shown mathematically that, rather surprisingly, these two effects exactly balance", says Stefan Rotter. "The average path length inside the liquid is thus always the same - independent of whether the liquid is transparent or opaque." At second glance, the situation is a bit more complicated: "We have to take into account that light travels through the liquid as a wave rather than as a particle along a specific trajectory", says Rotter. "This makes it more challenging to come up with a mathematical description, but as it turns out, this does not change the main result. Also if we consider the wave properties of light the mean length associated with light penetrating the liquid always stays the same, irrespective of how strongly the wave is scattered inside the medium."

Experiments in troubled water

The theoretical calculations describing this counterintuitive behaviour have already been published three years ago in a joint publication by Stefan Rotter's team and his colleagues from Paris (the French teams involve Romolo Savo, Ulysse Najar,



Copyright: TU Wien

Sylvain Gigan at the Laboratoire-Kastler-Brossel (experiment) and Romain Pierrat, Rémi Carminati at the Institut Langevin (theory)). Now the same research groups managed to verify the remarkable result in an experiment. Test tubes were filled with water, which was then obfuscated with nanoparticles. As more nanoparticles are added, the light is scattered more strongly and the liquid appears more turbid. "When light is sent through the liquid, the way it is scattered changes continuously, because the nanoparticles keep moving in the liquid", says Stefan Rotter. "This leads to a characteristic sparkling effect on the tubes' outer surface. When this effect is measured and analysed carefully, it can be used to deduce the pathlength of the light wave inside the liquid." And indeed: irrespective of the number of nanoparticles, no matter whether the light was sent through an almost perfectly transparent sample or a milk-like liquid, the average path length of light was observed to be always the same. This result helps to understand the propagation of waves in disordered media. There are many possible applications for this: "It is a universal law, which in principle holds for any kind of wave", says Stefan Rotter. "The same rules that apply to light in an opaque liquid also hold for sound waves, scattered at tiny objects in air or even gravity waves, travelling through a galaxy. The basic physics is always the same."

Savo *et al.*, Observation of mean path length invariance in light-scattering media, *Science*, 2017.

<https://doi.org/10.1126/science.aan4054>

FURTHER INFORMATION:

Prof. Stefan Rotter, stefan.rotter@tuwien.ac.at



20th
ANNIVERSARY

CIOE
CHINA INTERNATIONAL
OPTOELECTRONIC
EXPO

THE WORLD'S
MOST INFLUENTIAL
OPTOELECTRONIC
EXHIBITION

CIOE
2018

SEPTEMBER 5-8
SHENZHEN, CHINA

4 Sub-expos + 1 Photonics Innovation Pavilion



Scan and get there!



Register today and learn more at
www.cioe.cn/en

UNESCO proclaims May 16th as the International Day of Light

The 39th Session of the UNESCO General Conference has today proclaimed the date of May 16th as the **International Day of Light**. The proclamation of this annual International Day will enable global appreciation of the central role that light and light-based technologies play in the lives of the citizens of the world in areas of science, technology, culture, education, and sustainable development. The International Day of Light is an enduring follow-up to UNESCO's highly successful International Year of Light in 2015 that reached over 100 million people in over 140 countries. The International Day of Light was introduced to UNESCO by sponsors Ghana, Mexico, New Zealand and the Russian Federation, and supported at the UNESCO Executive Board and the General Conference by 27 countries: Argentina, Colombia, Czech Republic, Democratic Republic of Congo, Dominican Republic, Ecuador, Egypt, Finland, Iran, Ivory Coast, Kenya, Lebanon, Madagascar, Malaysia, Morocco, Nicaragua, Serbia, South Africa, Sudan, Sweden, Nigeria, Paraguay, Qatar, Togo, Vietnam, Uganda and Zimbabwe.

The International Day of Light is administered from UNESCO's International Basic Science Programme by a Steering Committee that also includes representatives from: the American Institute of Physics (AIP), the American Physical Society (APS), Bosca, the European Centres for Outreach in Photonics (ECOP), the European Physical Society (EPS), the International Association of Lighting Designers (IALD), the International Centre for Theoretical Physics (ICTP), the IEEE Photonics Society (IPS), the International Commission on Illumination (CIE), lightsources.org – the international network of accelerator based light sources, Light: Science and Applications, The Optical Society (OSA), Philips Lighting, the International Society for Optics and Photonics (SPIE), the Synchrotron-Light for Experimental Science and Applications in the Middle East (SESAME) and Thorlabs.

Partners worldwide are now making plans for an ambitious series of outreach and education activities in May 2018, with special focus on students, young people and the public at large. In addition, a flagship inauguration featuring Nobel Laureates and leaders in areas of education, industry, design and lighting will take place on May 16, 2018 at UNESCO headquarters in Paris, France.

Involvement and Opportunities: UNESCO welcomes all partners who wish to get involved in the International Day of Light either through organizing their own activities or by supporting the flagship event on May 16, 2018 at UNESCO headquarters in Paris. For event registration, enquiries about partnership opportunities, and any other questions, please contact:

John Dudley

IDL 2018 Steering Committee Chair
john.dudley@univ-fcomte.fr

Jean-Paul Ngome Abiaga

International Basic Sciences Programme
UNESCO HQ, Paris
jj.ngomeabiaga@unesco.org

Jorge Rivero González

International Day of Light Secretariat & Press Officer
dayoflight@eps.org

FURTHER INFORMATION

lightday.org

twitter.com/IDL2018 and #IDL2018

facebook.com/IDL2018

Back to OPTRO 2018

OPTRO 2018 took place under the French Ministry of Defense Sponsorship and was organized by 3AF – The French Aerospace Society. The symposium, which was held in Paris on February 6-8, gathered researchers, engineers, students and specialists from government, industries, universities and laboratories. It gave the opportunity to implement fruitful exchanges between colleagues of different countries and disciplines in the optronics field.

Thierry Michal, General technical Director of ONERA, was Honorary President of the plenary session and welcomed Mathias Fink, Director of the Langevin Institute for the Symposium introductory keynote. Fink showed how time reversal could be implemented on a wave using instantaneous change of the medium index, and then illustrated it experimentally by de-scrambling a previously scrambled smiley. After a couple of other keynotes by personalities from various horizons, Jean-François Coutris lead a round table on “*Optronics, a discriminant technology on the battlefield*”, which involved representatives from French Ministry of Armed Forces, Air Force and Navy.

During the following two days, more than 100 papers exposed recent advances in optronics in the field of space, defense and security, covering a large scope of scientific activity from emerging technologies to systems and data processing. The symposium was organized in three parallel sessions dealing with the following topics: Imaging & Systems, Sensors & components, Laser Sensor & Systems, Signal & Image Processing, Simulation, Photonics R&T and Emerging Technologies, Airborne Applications, Air, Land & Sea Defence Applications, Homeland Security Applications, Space Applications.

On February 7 & 8, OPTRO hosted an exhibition within the conference centre offering to all attendees and exhibiting companies in optronics an opportunity to exchange on

technical know-how and products: 24 exhibitors booths were installed in the reception room and exhibitors shared coffee breaks and lunch with speakers and visitors.

Despite the snowy conditions on Tuesday night, most (but unfortunately not all) of the registered attendees managed to reach the Hotel des Arts et Métiers, which was hosting the gala dinner. In this nineteenth century private mansion, the restaurant served traditional cuisine in a prestigious dining room overlooking the Eiffel Tower.

The next day the OPTRO2018 Award was awarded to Richard Hollins, DSTL, for his significant contribution in the field of Optronics as well as his dedication to OPTRO Symposium since many years. OPTRO 2018 best student paper was awarded to Léonard Prengère for his paper entitled “*High performance controllers for ELT-sized adaptive optics systems*” and the OPTRO certificate was awarded to Baptiste Fix for his paper entitled “*Nanostructured diode for infrared photodetection through nondegenerate two-photon absorption*”.

Finally, on February 8, the closing event was a B2B meeting on “*Lidar Technology for Defense and Security*” organized by EPIC, the European Photonics Industry Consortium.

FOR MORE DETAILS: www.optro2018.com

Claudine BESSON, OPTRO 2018 chairwoman
claudine.besson@onera.fr



FTTH Conference 2018 in Valencia

Focus: “We connect technology, policy and finance”

Under the High Patronage of His Majesty the King Felipe VI, the FTTH Council Europe held its annual “FTTH Conference” in Valencia (Spain), from February 13th to 15th. Key topics: new market panorama data and socioeconomic benefits of fibre.

As usual, latest figures of the “FTTH Market Panorama” prepared by IDATE – French consulting group – were released and presented by Roland Montagne, IDATE's Principal Analyst and Director Market Development. In the most important figures we note that, since September 2016, in one year, the number of FTTH/B subscribers in Europe increased by 20.4%. So, they were 51.6 million FTTH/B subscribers in September 2017 for EU39. During the last year, the significant increase in new subscribers was in Russia, which added 1 826 000 new subscribers, in Spain with 1 612 371 new subscribers and in France which added 1 067 780 new subscribers. The number of homes passed – homes connected with FTTH/B – in EU39 increased dramatically to reach more than 148 million representing a growth of 16% compared to September 2016.

For the European FTTH, Latvia is a confirmed leader in FTTH/B, championing the ranking for another year at 50.6% household penetration. Both Sweden (43.4%) and Lithuania (42.6%) remain on the podium confirming the growth from previous years. With a household penetration of 14.9%, France

is 29th in Europe. In the global ranking of economies with at least 200,000 households, the podium is UAE (94.3%), Qatar (90.4%) and Singapore (90.3%). France is only 36th. Commenting on these new data, Ronan Kelly, President of the FTTH Council said: “The findings of the Market Panorama are quite telling, we are now all looking towards the same goal of a fibre rich Gigabit society.”

Socioeconomic benefits

For the FTTH Council Europe, benefits for end-users and the society as a whole are core of its mission. So, a conference presented a new study – *The socioeconomic impact of FTTH* – carried out by WIK Consult (Deutschland) on the socio-economic benefits of fibre and the fact that fibre-based connectivity is transforming and enhancing the way we live, do business and interact. The objective was to identify more precisely the impact of fibre from the perspective of the end-users based on actual consumer experience. The study analyses the socioeconomic benefits of FTTH in two countries, Sweden and The Netherlands. The responses lead to the conclusion that, for the majority of FTTH

users, the fibre is about higher speed and better value for money, for instance 87% of the Swedish FTTH subscribers mention high bandwidth as the primary reason for purchasing a FTTH connection. It is also worth noting that 94% of Swedish non-FTTH users would consider subscribing to FTTH if it was made available in their area.

The study also looked at the impact of fibre on the economy and society leading to conclusions: in Europe, FTTH/B infrastructure is proven to have a positive impact on the environment with 88% less greenhouse gas emissions per Gigabit compared to other access technologies, and, in France, 4.8% more start-ups were created in municipalities equipped with ultrafast broadband compared to the ones with slower access.

In conclusion, you’ll find more information on the FTTH Council site – www.ftthcouncil.eu – and note that the 17th edition “FTTH 2019 Conference” will be held in Amsterdam (Netherlands), from 12th to 14th, March 2019.

Jean-Michel MUR, Honorary President of the Club « fibres optiques et réseaux » jm.mur@orange.fr

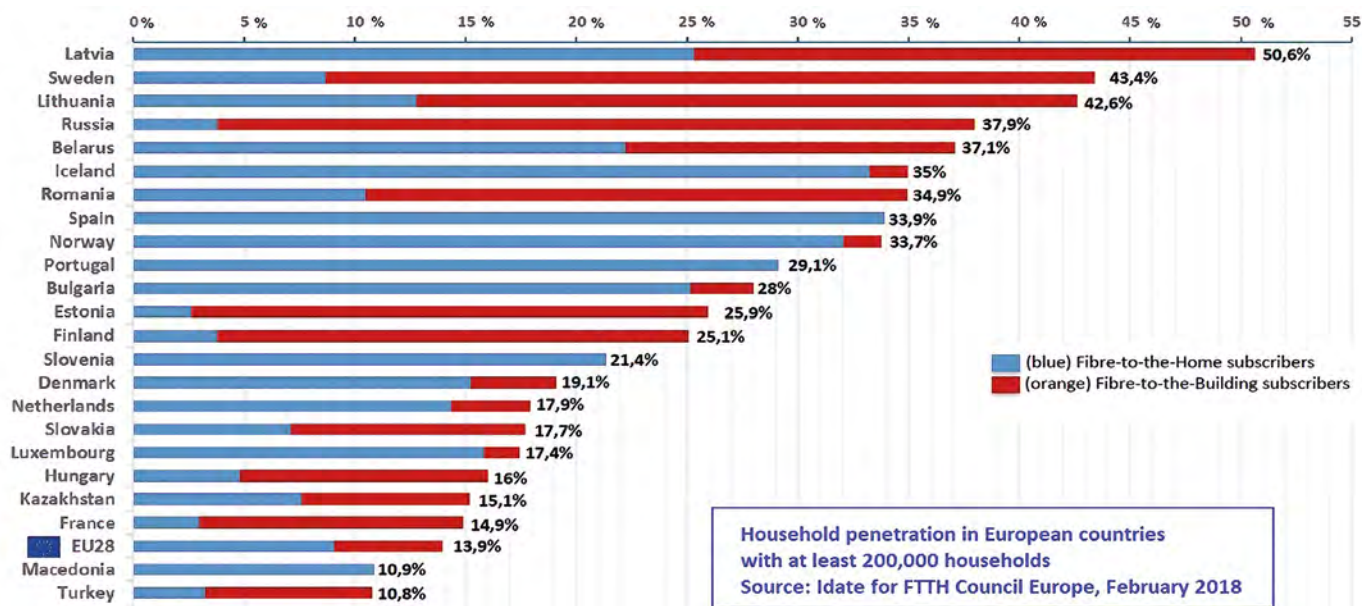

Boost your lab's performance



AWGs

- 2.4 GSa/s, 16 bit, 750 MHz
- 4, 8 and more channels
- <50 ns trigger latency

from less than

EUR 4.950,-

per channel

Typical Applications

Semiconductor testing, quantum computing, phased-array radar design & test, lidar, spectroscopy, NMR

Impedance Analyzers

- DC to 5 MHz, 1 mΩ to 1 TΩ
- 0.05% basic accuracy
- Compensation Advisor and Confidence Indicators

starting at

EUR 9.300,-

Typical Applications

High-Q dielectrics, capacitive sensors, supercapacitors, PV materials, component characterization

Lock-in Amplifiers

- Up to 600 MHz
- Scope, FFT, FRA, Sweeper, Imaging tool
- Optional: AWG, PID, PLL, Boxcar, Counter, AM & FM

starting at

EUR 5.200,-

Typical Applications

AFM, LVP, CARS, SRS, SNOM, graphene, optical PLL, THz, pump-probe, RFID, MEMS, NEMS, gyros, NDT, MRFM



Zurich
Instruments

Instrument Software

All instruments are equipped with LabOne®, the Zurich Instruments control software, providing a wealth of features, efficient workflows and ease of use. Access your instruments from any web browser or integrate it into your LabVIEW, MATLAB, Python, C, and .NET programs.

James Clerk Maxwell



Mainly known for his unifying theory of electricity, magnetism and induction, James Clerk Maxwell also concluded that light was an electromagnetic wave, and was responsible for the first true colour photograph.

Riad HAIDAR, haidar@onera.fr

MAIN DATES

13 June 1831 Birth in Edinburgh (Scotland)	
1854	Smith's Prize at Cambridge University
1855	Fellow of Trinity College
1856	Fellow of the Royal Society of Edinburgh
1859	Adams Prize awarded by St John's College
1860	Rumford Medal of the Royal Society
1861	Fellow of the Royal Society
1865	First version of Maxwell's equations
1871	Chair of Experimental Physics at Cambridge
1871	Maxwell founds the Cavendish Laboratory in Cambridge
1873	Version of the Maxwell's equations written in quaternion notation
5 November 1879 Death in Cambridge (England)	

James Clerk Maxwell was born on 13 June 1831 in the family home in Edinburgh, but his childhood was spent not in the city but in the countryside, on the Clerk Maxwells' vast Glenlair estate in Kirkcudbrightshire. This environment provided the ideal stimulation for his insatiable natural curiosity. His father John Clerk, a prosperous lawyer related to the Clerk baronetcy of Penicuik, had taken the second surname Maxwell after inheriting the Glenlair estate through his connections with the Maxwell family. He and Frances Cay formed an unusual couple, as they had met at a relatively late age and Frances was nearly 40 when she gave birth to James, their sole surviving child.

A slow start

As was customary in those days, James was initially taught at home by his mother. She had intended to continue overseeing his education until he was 13 and old enough to go to university. However, she contracted stomach cancer

and died when he was just 8. A young tutor was hired, but this arrangement soon fell through and it was decided that James should be sent to the prestigious Edinburgh Academy. Father and son therefore moved to the city to live with Isabella Wedderburn, John Clerk's sister, in November 1841.

James was now 10 years old. Having been brought up in the seclusion of the country estate, his mannerisms and accent were decidedly rustic and he was completely unused to the hustle and bustle of city life, making him appear shy and rather dull. His school début was inauspicious and his unusual interests in geometry and reading old ballads set him still further apart from his schoolmates. He did eventually find kindred spirits, however, including his lifelong friend Peter Guthrie Tait (1831-1901).

Turning point

His initial academic performances were mediocre, but his talent and genius were simmering just below the surface, and at 13 years, his gifts suddenly came to the fore and he ended the school year with the mathematical medal and several prizes in other subjects. The following year saw the publication of his first scientific paper, proposing a heuristic approach to oval curves.

In 1845, Maxwell left school for Edinburgh University, where he was soon dazzling his contemporaries. His classes left him plenty of time to improvise elegant physics experiments, including one in which he observed shear-induced double refraction in blocks of gelatine, using polarizing prisms given to him by William Nicol (1770-1851)! Maxwell was now 18, and that year published two groundbreaking papers.

In 1850, Maxwell left Scotland for Cambridge. He enrolled at the prestigious Trinity College, where he studied under William Hopkins (1793-1866), an academic known

Your Partner for Precision Optics and Optical Systems.

SPECTROS AG 4107 Ettingen Switzerland Tel. +41 61 726 20 20

www.spectros.ch

SPECTROS OPTICAL SYSTEMS



for his success in nurturing genius. The young James, already an accomplished mathematician, blossomed under his coaching, such that in 1854, he not only gained his degree in mathematics but was also joint winner of the prestigious Smith's Prize with Edward John Routh (1831-1907). He decided to stay on at Trinity and apply for a fellowship, which he was awarded the following year, charged with giving lectures on optics and hydrostatics.

Early work

Maxwell used coloured spinning tops invented by James Forbes (1809-1868) to demonstrate that white light results from a mixture of red, green and blue. He presented his paper "Experiments on Colour", in which he set out the principles of colour combination, to the Royal Society of Edinburgh in 1855. Colour perception was not his only interest, however, and in his paper "On Faraday's Lines of Force", he proposed a mathematical formulation of the theories propounded by Michael Faraday (1791-1867) and André-Marie Ampère (1775-1836) on electricity and magnetism.

In early 1856, learning that his father John Clerk Maxwell had fallen ill, James decided to return to Scotland. He heard that a chair of natural philosophy had fallen vacant at Marischal College in Aberdeen. He easily obtained the post, but his father died shortly afterwards, on 2nd April, leaving him all alone in the world at the age of just 25 years. James left Cambridge in November and was appointed head of department at Marischal College, in charge of planning the syllabus and preparing the lectures. He now divided his time between Aberdeen, where he lived for the six months of the university year, and the family home at Glenlair.

When St John's College, Cambridge, chose the stability of Saturn's rings as the theme of the 1857 Adams Prize, Maxwell took up the challenge and devoted his first two years of research at Aberdeen to the problem, which had been puzzling scientists for 200 years. Through pure mathematical reasoning, without the aid of experimental observations, he concluded that the rings must be made up of tiny particles orbiting the giant planet – a theory confirmed by the Voyager probe in the 1980s. Maxwell won the prize for what remains "one of the most remarkable applications of mathematics to physics" according to Georges Airy (1801-1892).

In 1857, Maxwell met Katherine Mary Dewar, the daughter of the Reverend Daniel Dewar, then Principal of Marischal College. They became engaged in February 1858, and were married in Aberdeen in June 1859. However, neither this family connection nor his established scientific status protected him when Marischal College merged with King's College to form Aberdeen University in 1860. There was only room for one professor of natural philosophy in this new structure, and being the younger of the two, Maxwell was forced to relinquish his post and look for one elsewhere.

Leti's solutions for innovative photonics



Founded in 1967, Leti is a French technology research institute that pioneers micro- & nanotechnologies, with 8500 m² of cleanroom space and a clear IP policy. The typical maturity level of Leti's activity is within TRL3 and TRL6.

Leti's Optics and Photonics division was created later in 1978, tailoring differentiating applicative solutions for global companies, SMEs and startups. The division works hand-in-hand with its industrial partners to develop hardware technologies enabling smart, energy-efficient and secure photonics products for industry.

Leveraging a new dedicated Photonics area within Leti's world-class pre-industrialization facilities, its multidisciplinary teams deliver solid expertise in all-wavelength imaging (visible, infrared, THz), information displays, solid-state lighting, optical data communications, optical sensors, amongst other technologies. Leti photonics technologies are based on a wide range of materials, from III-V and II-VI materials, to 200 and 300 mm silicon wafers.

With staff of more than 300, a portfolio of +500 patents, Leti's Optics and Photonics division is based within Grenoble greater area, France. This area gathers a dozen of leading industrial companies and startups providing microelectronics and photonics solutions - such as STMicroelectronics, SOITEC, Sofradir, ULIS, Aledia, Microoled, Mirsense and eLichens. Within this ecosystem, several thousands of persons tailor applicative solutions to build a better future. Leti's Optics and Photonics division also has staff in the Silicon Valley and Tokyo. It has launched 7 startups so far, two of them being now IR imaging leaders: Sofradir and Ulis.

Follow us on www.leti-cea.com and [@CEA_Leti](https://twitter.com/CEA_Leti).

INTERESTED IN DOING BUSINESS WITH US?

LETI, technology research institute

Laurent Fulbert

Deputy Head of Leti Optics and Photonics division
Strategic and Program management

Laurent.fulbert@cea.fr - +33-438783845

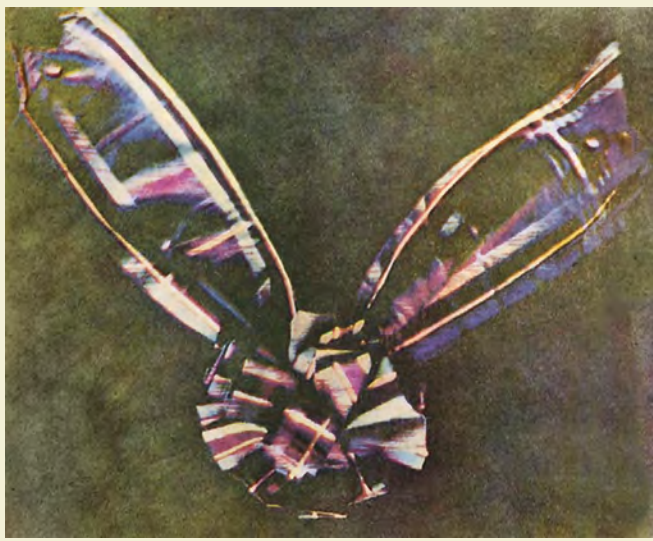

The first projected colour image : Maxwell's tartan ribbon (from Wikimedia Commons, in the public domain).

Giant steps for science

That same year, Forbes vacated the chair of natural philosophy at Edinburgh and Maxwell duly applied. However, he encountered fierce competition, not least from several of his friends, including Tait and Routh. Arguing with some justification that Maxwell was not the best person to teach poorly equipped students, the selection committee finally chose Tait.

Maxwell nevertheless managed to obtain the natural philosophy chair at King's College in London. He was to spend six years there, and although the teaching load was far heavier than it had been at Marischal College, he still managed to conduct some of his finest experiments during this period. His research on colour perception earned him the Royal Society's Rumford Medal in 1860. More noteworthy still, he succeeded in producing the first true colour photograph, using red, green and blue filters. He also developed his ideas on the kinetic theory of gases.

This period was above all remarkable for Maxwell's advances in electromagnetism. He was able to summarize all the connections between electricity and magnetism in

a handful of equations, publishing an initial version of his work in 1865. This was a prodigious feat of synthesis, as none of the laws he so brilliantly unified - and even extended, by substantially modifying Ampère's circuital law to make his unified description more coherent - was more than half a century old. He went even further, as his equations indicated that electromagnetic fields propagate as waves at approximately the speed of light, and he therefore deduced that light is an electromagnetic phenomenon. This link between electromagnetism and light, confirmed by Heinrich Hertz (1857-1894)'s momentous experiment in 1887, was one of the greatest discoveries ever made in physics.

Final round

Maxwell left King's College and London in 1865, returning to his Scottish property at Glenlair. He nevertheless remained in contact with the scientific world, regularly travelling to Cambridge and even accepting the first ever post of professor of experimental physics there in 1871. It was in this capacity that he drew up the plans for the Cavendish Laboratory, officially opened on 16 June 1874.

Exploiting William Hamilton (1805-1865)'s quaternion number system, Maxwell published a more fully developed version of his partial differential equations in 1873, in his book *A Treatise on Electricity and Magnetism*. These famous Maxwell equations, which we now know in the vectorial form given to them by Oliver Heaviside (1850-1925) and Willard Gibbs (1839-1903), remain his crowning achievement.

In May 1879, in the middle of the Easter Term, Maxwell's health suddenly declined. He soldiered on, managing to give all his lectures, then returned to Glenlair with his wife Katherine, who was also in poor health. The next three months were marked by intense suffering, which he bore with fortitude and without sadness. When he returned to Cambridge in October, he could barely walk, and died on 5 November 1878, aged 48, having laid the physico-mathematical foundations for the revolution of relativity that was to take place in the early 20th century. ■



FAST, RELIABLE, LASER REPAIR & REPLACEMENT

LASER REPAIR

- Argon
- Solid State
- Computer to Plate
- Dry Film



LASER APPLICATIONS

- Biotechnology
- 3D Printing
- High Volume Printing
- Semiconductor Inspection



MARKETING FOR *the photonics industry*

Benoît D'HUMIÈRES - TEMATYS - bdhumieres@tematys.com

You create a start-up, diversify the business of your SME, expand your product range; every new activity, every new business, starts with a concept. You, your partners, your team, have an idea for a product. Your dream product will be better and cheaper or it might not even exist yet, but it will meet market requirements. You are going to make this concept a reality.

It is a long process, practically an adventure. Because, though you own the idea and though you can shape your concepts to match your wishes, the reality we are talking about is not yours. It is that of your customers; their needs and their expectations. In the photonics industry, reality is also constrained by the limits of physics and technology. A physical component or product is always a compromise. It can perform some functions, but not all. It can achieve a certain level of performance, up to a certain limit. Its cost must be justified by the added value perceived by the customer.

In other words, the concept is in your head, but business reality means that all stakeholders in the value chain are involved: partners, subcontractors and, above all, customers. Even in high-tech fields such as photonics, a successful product is the coming together of a dream and this business reality. Marketing is about bringing these two things together; it is listening to market requirements and using them to define future products. It is also about creating a message for future customers to discover the value of your products and be convinced to buy them. But we will provide a detailed definition of marketing later.

Like any high-tech business, the photonics industry is first and foremost about trade!

Photonics produces hardware, *i.e.* manufactured components and systems. It is a high-tech business and has very close ties to research. Several entrepreneurs started their careers as researchers. However, like any business sector, the mission of the photonics industry is trade – the exchange of goods and services for money. Statement of the obvious, no? Everyone must judge this for themselves and those around them.

This is not the only feature shared by all high-tech industries. There is another one that is equally important: users never buy technology. They buy a function performed using technology built into equipment. What matters to them is the features of the product, what it can do, under what conditions it can be used, its limits, its sturdiness and, above all, whether it meets their needs. These features will have a particular influence on the marketing used in photonics.

We are humbled by this observation. So much effort to master technology! To use it in equipment! To make sure the product works! And you are competing for your prospect with outdated technology, which is more limited but has been used for 20 years!

PHASICS
The phase control company

High resolution
wavefront sensors

LENS
QUALITY
CONTROL

QUANTITATIVE
PHASE IMAGING

LASER
OPTIMIZATION

Visit our new website:
www.phasics.fr





Types of Photonic Systems	Sensing & imaging systems	Communication systems	Screens, displays, projectors, ...	LED, OLED, lamp systems	Photo-voltaic systems	Laser & production systems
Photonic Functions	Acquiring information	Transmitting information	Delivering information	Light providing	Energy providing	Manufacturing
Examples						

Figure 1. All the functions that can be performed using photons.

Special features of the photonics industry

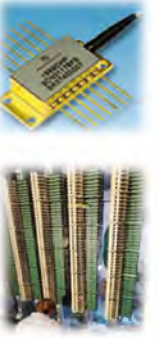
Beyond these general features, photonics also has some special features that must be taken into account in marketing. The first is its versatility. Indeed, we should bear in mind that the European Commission has identified it as a key enabling technology. *Figure 1* shows all the functions that can be performed using photons.

Consequently, we will use lasers for communicating as well as for lighting, measuring, cutting, etc. Or the same microspectrometer will be built into an allergy analyser and a river pollution monitoring system. At Tematys, we often approach a new technology developed by a researcher as a 'solution seeking a problem'. And a 'good' problem, from a business perspective, is one that customers are prepared to pay a sufficient amount to resolve.

Another special feature is that photonics is a slow-growth market. It takes ten years on average for a photonics start-up to really take off. There are several reasons for this. As for any hardware industry, developing a product requires more initial capital and

investment than a software business. Firstly, photonics engineers, but also electronics engineers, software developers, precision engineers and, of course, experts in the field of the target application (medical, environment, industry, etc.) must be brought together. Ensuring effective communication between all these professionals is not always easy, especially since physics and materials do not go together easily. The development and 'debugging' phase of an industrial prototype is never simple.

The second reason for the slow growth is related to the versatile nature of photonics. The sector is not a market in and of itself, like the automotive market. It is geared to areas of application. But doctors, chemists, materials engineers, telecom engineers, even the general public, still need to be convinced of the performance and added value of photonics.

And even when they discover the benefits of photonics, they are not always prepared to invest astronomical sums to test new techniques and see how they can be used. Especially since the competition is fierce. How many technologies use photovoltaics? Wind power, fossil fuels, hydroelectric power, nuclear

power, geothermal energy, tidal power, biogas energy and many others.

Photonics engineers face a difficult issue. Photonics has a lot of potential for its target markets, but who is prepared to pay to test it until the market becomes large enough to sustain itself? Lots of photonics product development strategies stem from this problem such as, for example, the use of CMOS to take advantage of production lines that are already profitable for electronics or the removal of 1.5 μm components, the development of which has already been funded by the telecom companies.

Depending on other sectors to make progress is clearly a powerful brake.

Demystifying marketing

Photonics, with its special features, is therefore a market full of opportunities, but also sprinkled with uncertainty and pitfalls to avoid. The role of marketing is to suggest and, above all, to underpin a route conducive to the growth and prosperity of the business. The mission of marketing is to understand current and future market requirements and to give managers the means to choose

a strategy, based on information that is as logical and reliable as possible.

Once the strategy has been chosen and products developed in conjunction with future users, the marketing team expresses the added value of the product in a sales strategy and prepares marketing materials. Here is a summary of the 4 tasks of marketing.

1. **Study markets and trends.** This is often what is meant by 'market research'. This task includes:
 - studying and quantifying demand (existing or potential);
 - forecasting future developments;
 - analysing the competition.
2. **Define and specify future products and associated business models.** Market research is a 'snapshot'. But it is only a descriptive and forward-looking document. The second task of marketing is to use it to define future products and associated business models. As we will see, this stage is crucial, complex and full of trial and error. This is where concept meets business reality. We will also see that there are ways to go faster and underpin this period of uncertainty.
3. **Prepare market access strategies and promote products.** Having a 'well-positioned' product, *i.e.* one

that meets the requirements of users, is not enough! How many entrepreneur engineers have asked themselves the question: "*I have better products than the competition, but my sales are not taking off! Why?*" Because the market already works without your product, because customers do not know you, because your business is very small, which does not reassure big companies – there are many possible explanations. And it is the role of marketing to prepare 'market access strategies', *i.e.* action plans and marketing materials to 'reach' customers, whatever the obstacles, barriers, habits and prejudices. Market access strategies are most often missing from business plans.

4. **Prepare growth strategies.** The last task of marketing is focused more on the long term. It involves developing a growth strategy for a business or activity. Knowledge of the market and the competition is essential for achieving this because a growth plan depends not only on internal R&D, but also external acquisition opportunities. This is especially true in photonics, which is made up of a myriad of specialist SMEs.

Useful definitions

Market research: studying and quantifying the business demand for a product, analysing associated uses, forecasting future developments, analysing the competition.

Positioning study: studying the definition of the best commercial product imaginable using a given technology in a given sector of application. A positioning study prepares one or more product-market pairs and analyses and compares their respective market potential. Designing a product/market pair involves describing a feature and an added value (the offer), a target market, an associated business model and a position in a value chain. The criteria for comparing product-market pairs depends on the target sector, the target customer and also the company handling the product and its investment capacity.

Market access strategy: action plans and marketing materials to 'reach' customers, whatever the obstacles, barriers, habits and prejudices. Market access strategies are most often missing from business plans. Market access strategies meet the requirements of the sales process:

- how to make people recognise a need and identify our product as a potential solution;
- how to let customers assess the product and the associated offer;
- how to remove or reduce obstacles to buying the new product;
- how to organise the sale itself;
- how to provide the product and related services;
- how to ensure efficient after-sales service.

HEXAPOD

- 6 degrees of freedom
- vacuum compatible versions
- pivot point configuration via ergonomic software

High performances for your **precision** positioning: optics, space, astronomy, automotive, synchrotrons...

PUNA

simple and affordable

- resolution 0.5 µm
- travel ± 30 mm; ± 20°
- payload 25 kg
- height 200 mm



ZONDA

high precision and stability

- resolution 0.1 µm
- travel ± 200 mm; ± 20°
- payload 400 kg
- height 640 mm



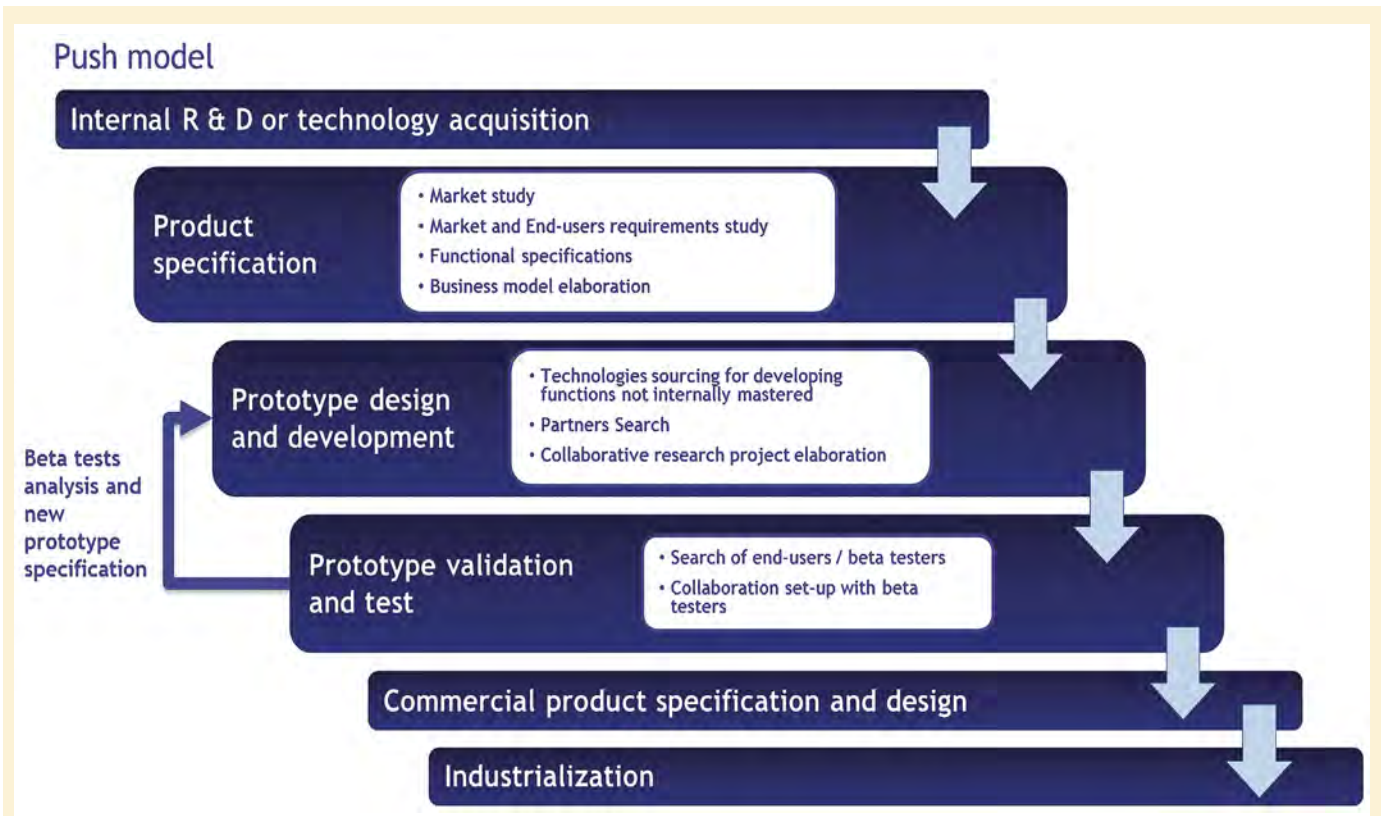

Figure 2. Marketing is an integral part of the development process for photonics products. *Push* model: the product is developed based on an established technology (source: TEMATYS).

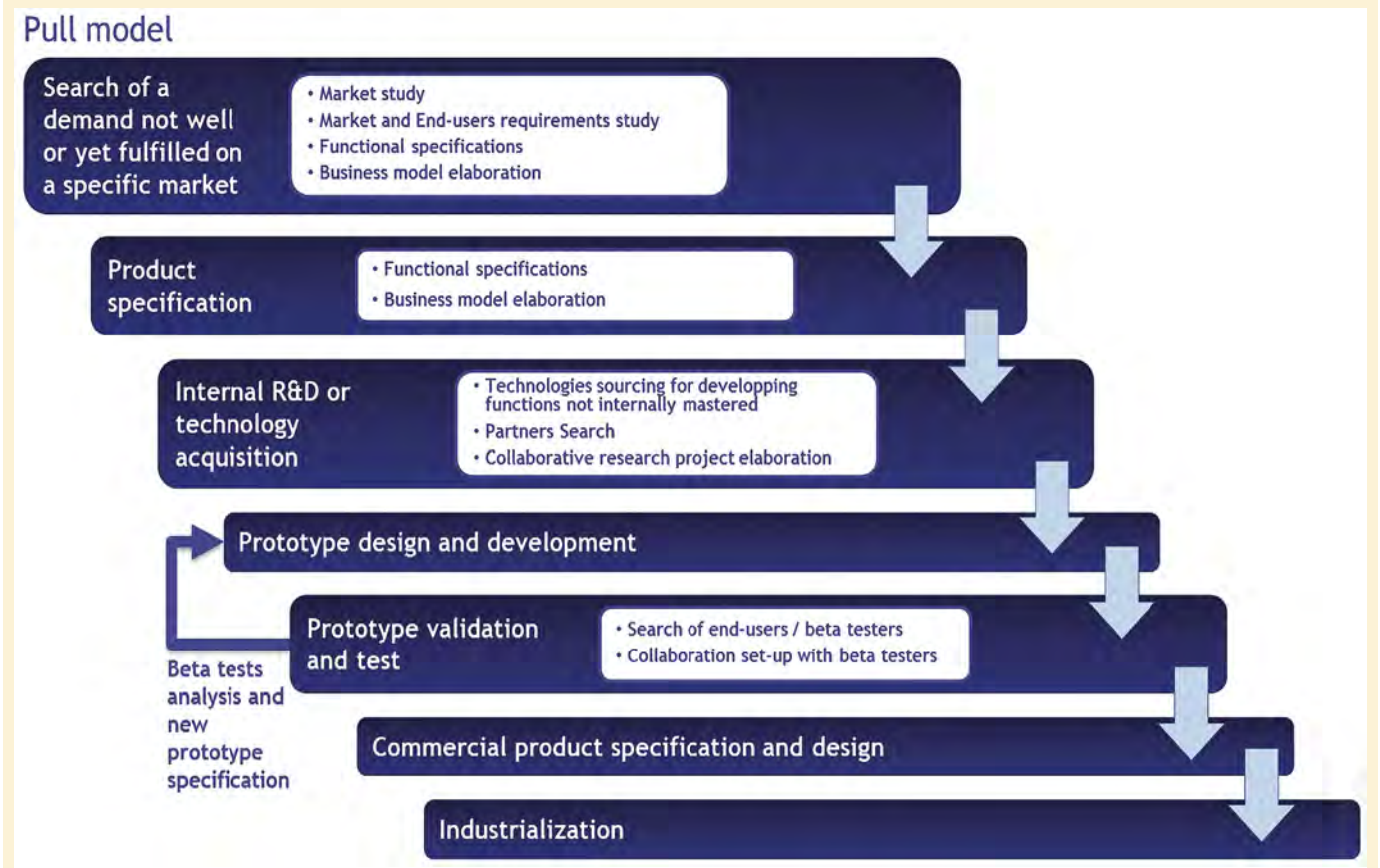

Figure 3. Marketing is an integral part of the development process for photonics products. *Pull* model: the product concept is defined with customers first and then developed based on a technology harnessed internally or 'sourced' externally (source: TEMATYS).



Salon international des
technologies, composants
et systèmes optiques

15.-17.05.2018

FRANCFORT

Pole position en technologies optiques

Optatec, qui présente une offre mondiale de produits, composants et solutions systèmes ainsi que d'applications mettant en œuvre les techniques optiques les plus innovantes est incontestablement LE salon leader de ce domaine. Sur cette 14^{ème} édition, les quelque 600 fournisseurs originaires de plus de 30 pays accueilleront à Francfort des experts décisionnaires d'environ 55 pays.

- Composants optiques
- Optomécanique/ Optronique
- Fibre optique / Guides d'ondes optiques
- Composants laser
- Systèmes de fabrication

SPIE Congrès
"Optical Systems Design"



www.optatec-messe.de

Organisateur: P. E. SCHALL GmbH & Co. KG



+49 (0) 7025 9206-0

optatec@schall-messen.de

What can we expect from marketing in the photonics industry? In this sector, we have seen that technologies can often serve and target several applications, only some of which will be good markets able to sustain business growth. In the case of start-ups, the choice of target applications should be even more drastic because they do not have the means to pursue several ambitions at once.

A structured marketing campaign allows you to streamline your choices by listening to customers before even developing the product and to base your decisions on an analysis of the facts and definition of risks. There is no certainty in marketing, since its aim is to understand the future expectations of customers and these can rarely be clearly defined. However, a good market study will systematically identify and assess potential applications and help focusing investments on areas with the highest chances of success. In other words, it underpins a growth strategy.

Let's look at a deliberately hypothetical example. A French start-up has developed a sensor that can be used on naval ships, on agricultural machinery for papaya cultivation and in light vehicle. The most attractive market – the jackpot – is the automotive industry, with their very high volumes and a strong domestic industry to serve as a springboard. But everyone knows how difficult it is to penetrate this market, since you need to provide guarantees on the reliability of the product, financial sustainability, production costs as well as industrial production infrastructure and just-in-time logistics. For papaya, we may question the investment opportunities in this agricultural sector, especially in France. Finally, the shipping market does not offer very high volumes, but the added value of the product is regarded well enough to convince early adopters. Going down this route will allow the start-up to generate revenue quickly, better manage the industrialisation of its sensor and reduce the time required to build good partnerships to penetrate the automotive market at a later date.

Marketing at the core of the product development process

We have looked at marketing tasks and their usefulness in developing activities tailored to market demand. Talking to customers to develop products that will suit them best, understanding and monitoring the competition, developing access strategies and materials to promote products: all of these tasks are common sense.

However, in high-tech industries, the word 'marketing' is still seen as strange, if not taboo. Furthermore, some public and semi-public innovation support organisations find it normal to spend over a million euros to support a technological development while requiring nothing more than vague market research costing ten thousand euros.

Yet marketing is an integral part of the product development process. In fact, it is its *raison d'être*, since its goal is to create a product that will sell as well as possible and increase sales.

Figures 2 and 3 explain when marketing plays a role in the product development process (white boxes). The product definition phase is naturally based on an understanding of the market and demand driven by dialogue with future customers. But the validation phases also benefit from marketing work. Indeed, the first users of the prototype(s) are among the first people contacted during the product definition phase.

Figure 2 shows a typical development process for a technological product. It is called the *push* model because the product is initially based on a technological development about which we ask ourselves the question: "what could this be used for?"

Figure 3 describes another approach, more steeped in business logic. This is the *pull* model, where, even before worrying about technical developments, we seek to invent a product concept based on an in-depth analysis of the market and customer requirements. This phase is therefore almost entirely marketing-based. This model

CMS Series

MULTISPECTRAL CAMERAS



Detect, separate, sort, thanks to multispectral images.

8 spectral bands + 1 B&W
20 to 40 nm spectral resolution
1.3 Mpx raw resolution
USB 3.0 / GigE - 10bits

Small footprint (52x52x22mm)
Low weight (< 60g)

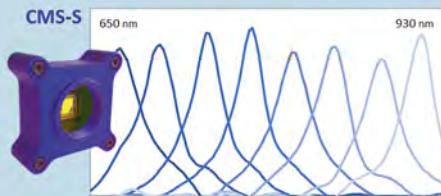
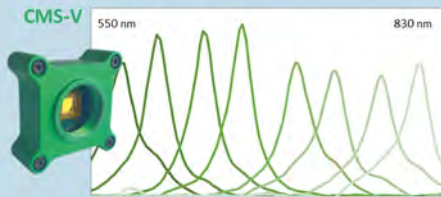
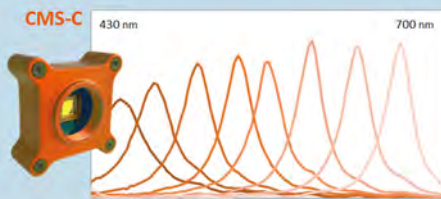

For more information
Web : www.silios.com
Email : contact-cms@silios.fr

is at the heart of the approach recommended by entrepreneurs such as Steve Blank, who taught entrepreneurship at Berkeley, Stanford, Columbia, NYU and UCSF [1]. And it is just as suited to hardware development activities as it is to digital business.

Developing your positioning and strategy takes time

Whichever approach is chosen, *push* or *pull*, developing product positioning and an access strategy takes time. Marketing seeks to build a future. It is necessarily uncertain. It is rare to find the right formula the first time. Paul Millier of EM-Lyon talks about the state of transition [2] during which the product is remodelled through trial and error – we ‘learn’ the market and break down the barriers and obstacles to putting the product on the market.

Similarly, Steve Blank recommends a gradual and repetitive approach focused entirely on interactions with future users and customers who validate the product definition at each stage of its design.

Each stage (Fig. 5) is a cycle where we ask users and customers about their needs and whether the design being considered meets their expectations. We repeat this several times before moving on to the next cycle, once we are satisfied with the current stage. The first

two cycles of this process (*customer discovery* and *customer validation*) are based solely on paper and simple proofs of concept. Development of the first prototype does not occur until the 3rd cycle (*customer creation*). In other words, the start of the product definition process is comprised entirely of marketing. This is probably a bit radical for a very technological industry such as photonics, but it has the advantage of reminding us that the aim of entrepreneurship is customer satisfaction.

In any case, these product development processes involve a great deal of contact with users and future customers. Organising all these meetings, carrying them out, interpreting them, analysing the lessons learned from them and turning them into operational specifications obviously takes a long time. This is especially true for the photonics industry, since it is diverse and versatile. In conclusion, taking time to design the product is normal, but taking time to design it without leaving your office or workshop or waiting until the product is finished before seeing customers is a risky move.

Photonics marketing: a skilled profession

How can you make your product definition study a success? Marketing is not an exact science and although CAD allows us to simulate a product and its

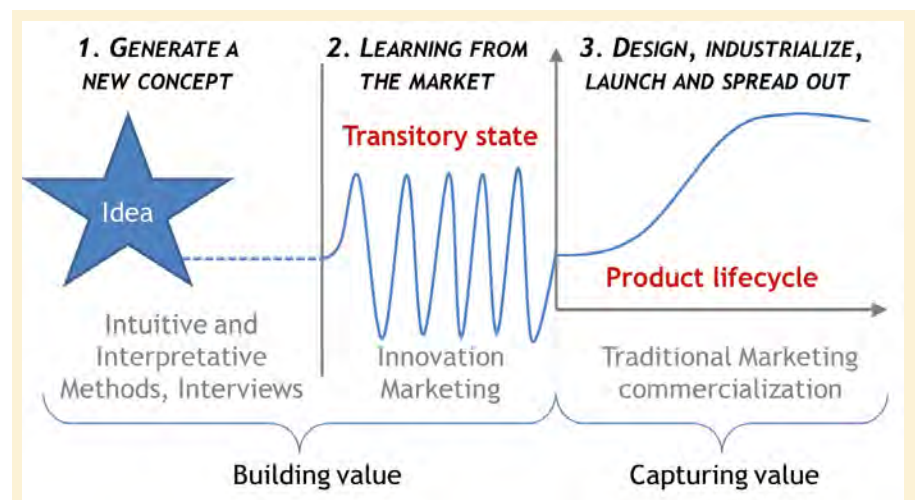

Figure 4. According to Paul Millier, technological product development goes through a transitional state involving uncertainty and testing during which the product is remodelled through trial and error; we ‘learn’ the market and break down the barriers and obstacles to putting the product on the market [2].

behaviour, no software can predict its commercial future. What makes marketing technological products complex is working in a highly uncertain environment. However, choices must be made in order to define a product! So, how do we make decisions? How do we underpin this process?

Some methods, such as those of Steve Blank and Paul Millier, already allow us to ask the right questions at the right time and focus on the goal, *i.e.* designing a product that will sell. But beyond these methods, marketing technologies is, above all, a skilled profession, a form of craftsmanship. This savoir-faire is especially crucial for:

- **Building a trusting relationship with the contact.** You will often question specialists and experts who are potential buyers of the product. When you meet them, you will have only a few seconds to convince them that talking to you is worth it and not a waste of their time. You should prepare meticulously and methodically for interviews.
- **Help the contact to look to the future and assess a product that does not yet exist.** Once you have the interview, you then need to create conditions in which the contact can give you useful feedback. But there is nothing more difficult than getting people to talk about a product that does not exist.

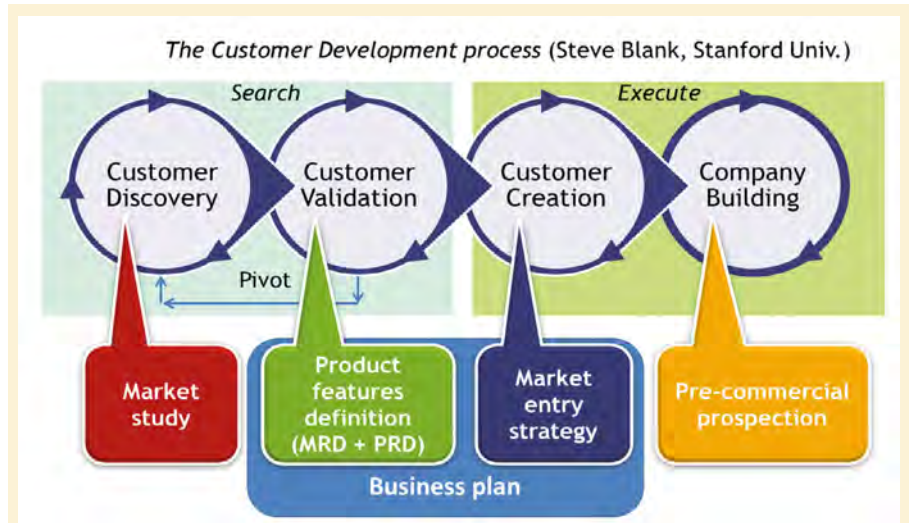

Figure 5. Steve Blank's customer development process [1].

- **Interpret qualitative, incomplete and uncertain information.** Designing a new product is a gamble and is often based on a hunch. Even when you put a lot of effort into establishing contacts and interviews, you will have to make judgements based on qualitative, incomplete and uncertain information. Product definition is like investigative journalism; you have to collect information, continuously assess the reliability of the information you are being given, identify trends from weak signals, be able to generalise based on individual opinions, etc. Another pitfall to avoid is only

listening to one customer, especially a major one. Because of their prestige, you might be tempted to incorporate all of their requests for adaptations related to their specific needs. But be careful not to become a subcontractor, prevented from producing a generic product that can be sold to a larger market.

- **Accept that the expectations of your future customers are different from what you thought – and find solutions to meet them.** Product design is a process of trial and error, as previously mentioned. You will definitely be surprised by your contacts' assessments of your prototypes and



**LA FLEXIBILITÉ ET L'EXPERTISE
AU SERVICE DE L'INNOVATION**



Hi-Tech Detection Systems

OPTOÉLECTRONIQUE

DES SOLUTIONS ET UN SERVICE SUR MESURE POUR PETITES À TRÈS GRANDES SÉRIES - PRODUITS STANDARDS - SOLUTIONS SPÉCIFIQUES

EMETTEURS UV-VIS-IR
LEDs et Power LEDs / Sources lumineuses à LED ou Xénon
Diodes lasers / Lampes flash Xénon / Corps noirs miniatures

DÉTECTEURS UV-VIS-IR
Pyro détecteurs / Thermopiles / Imageurs thermiques
Photodiodes PIN et APD / Si, InGaAs / Barettes, quad
SPCM, CPM, Compteurs de photons
Modules SiPM Lynx



APPLICATIONS : INDUSTRIELLES, GRAND PUBLIC, AÉRONAUTIQUES, MÉDICALES, BIOMÉDICALES, SCIENTIFIQUE, DÉFENSE, AUTOMOBILE

Société HTDS - info@htds.fr - www.htds.fr - Tel : +33 (0)1 64 86 28 28

Networking is a Worthwhile Investment



Networking is one of the main reasons to attend industry events like exhibitions, conferences, and meetings. Of course the presented material will be instructional and informative, but the opportunity to meet new people and interact with peers is also extremely valuable. Networking time is sometimes underrated by organizers and attendees. Some events schedule coffee breaks that are too few and too short. Or, they use the break as a time buffer to recuperate time from presenters who exceeded their allotted speaking time. At EPIC events, networking is a key ingredient to the success of all our initiatives. This is why at our meetings, presentations are short, time is imposed and respected, and there are numerous and long breaks for attendees. During EPIC meetings, we make it *a priority* to personally introduce attendees to each other, and we share a participants list that includes every attendee's picture, biography, and company description. At EPIC, we take you to the handshake, the rest is up to you! EPIC organizes 20-30 events per year, mainly technology workshops, but also purely networking events. If you would like to be part of an active international network of photonics experts and leaders, you are invited to become member of EPIC! ■

CONTACT |

EPIC

Carlos Lee, Director General
at EPIC (European Photonic
Industry Consortium)
carlos.lee@epic-assoc.com

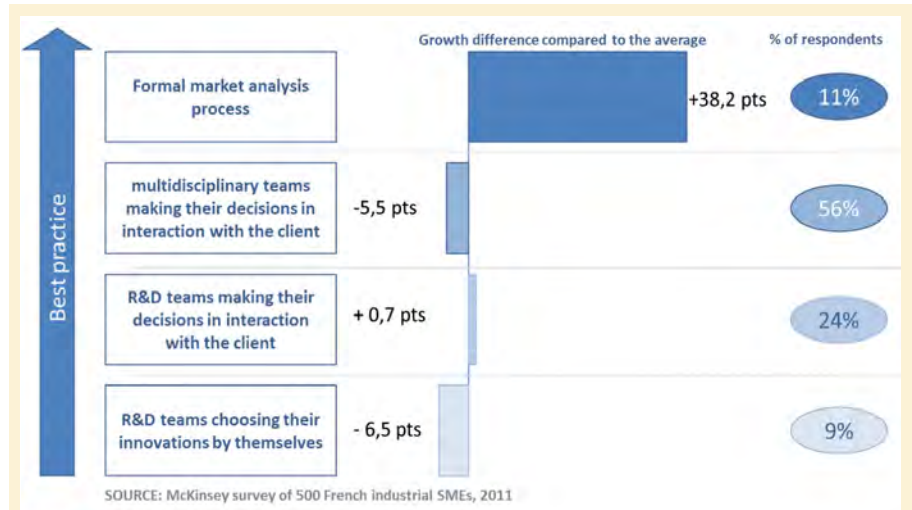

Figure 6. Comparison of the growth differential in relation to the average of 500 French industrial SMEs (study carried out in 2011, all sectors [3]).

designs. You will also need to prepare to rethink your ideas which, remember, are only hunches, since they have not faced business reality.

The marketing approach is even more complex in a high-tech environment as the skills necessary for successful marketing run counter to what engineers have been taught. However, it is similar to the scientific research approach, where we submit a hypothesis that we then seek to validate through experiments.

Hiring a marketing firm for success

Since most photonics companies are small or very small businesses, they rarely have an internal marketing department. They have to call on the services of specialist firms. But in the context of an artisanal industry that aims to perform an activity engineers find counter-intuitive, it is difficult to know whether the marketing firm in question will be up to the task and provide sufficient, reliable information that will allow a decision to be taken with confidence.

So how do you choose and work with a marketing firm? Here are some practical tips to start the process:

- **Make your request as clear as possible.** The clearer the request, the clearer the response. Convey your

expectations, your goals and your questions. Try to describe what, for you, would be a successful assignment. For their part, the marketing firm will specify what they can provide and the limits of their involvement. Do not be afraid to spend time interacting with the marketing firm at this stage.

- **Assess their skills via their relationship with you.** Can they reassure you and build a trusting relationship with you? Do they listen to your expectations? Do they give a clear description of their methodology? If they can reassure you, they will also be able to reassure the contacts they interview.
- **Tell the marketing firm what actions you have already taken before the start of the assignment.** In most cases, you will not have waited for a marketing firm to start the process and establish contacts. Tell the marketing firm so they do not retrace your steps and provide you with confirmation of what you already know, whilst irritating your contacts whose time will have been wasted.
- **Accept uncertainty and the unexpected.** We have discussed at length the extent to which marketing deals with the future, *i.e.* an uncertain topic. Accept the feedback of the contacts interviewed even when it is negative. They are the ones who will take your product forward.

• **Respond to requests from experts and future users, even if they surprise you.** Not all feedback is negative; on the contrary, when your concept meets an expectation, those interviewed often want to go further. They ask when the product will be available and want to know whether it will suit their specific application and whether it will work in their technological environment. But often the use they envisage is very different to what you have in mind. If this type of request is made, that is great news — it means your product has perceived value. So you must answer the questions, even the most absurd — the success of your product may depend on this unexpected use.

But in any case, remember two key points:

- A marketing assignment for tens of thousands of euros seems expensive to provide ‘a few slides’. But this is only a fraction of the cost for technical development of your product, which will cost you at least several hundred thousand euros, taking into account wages and investments.
- If the conclusions of the market research are negative and the marketing firm recommends (using practical and sensible arguments) making significant changes to your concept or, worse, not launching it because the feedback on the ground is negative, listen to them, even if it is not very pleasant. That just tells you that your dream does not pass the business reality test. Taking this external advice into account will probably save you hundreds of thousands of euros in unnecessary development costs.

Whether you do it internally or entrust it to a marketing firm, market research is always profitable because

it brings you closer to customer expectations and allows you to make logical decisions with confidence.

Marketing: an ongoing activity

In 2011, the marketing firm McKinsey proved that marketing is an investment for industrial SMEs and not a burden. 500 French industrial SMEs from all sectors were surveyed. The results were clear: Those that had a structured analytical and market-based approach experienced growth much higher than the average (Fig. 6).

In contrast, those that had only an informal process of listening to customers (often a single customer, the most prestigious) are at a disadvantage. They are close to their customers, but they do not take back lessons learned and useful information to create growth strategies. They are ‘consumed’ by the day-to-day and urgency. They have their ‘noses to the grindstone’.

In conclusion, French photonics SMEs often have significant expertise in their field, but do not manage to grow, often for lack of an ambitious growth strategy that can convince investors. However, French photonics SMEs also have the creativity and excellence of French research, which is just waiting to be used.

In our opinion, this sector is a gem that is not yet aware of its potential and capacity to create tomorrow’s large industrial companies. The reluctance to leave the comfortable cocoon of technical vision to address business logic based on a structured and meticulous approach to marketing is one of the main reasons for this limitation. ■



*You thought we were
nothing more than
Blackbody
Experts?*

THINK AGAIN!

*Discover our range of
Integrating
Spheres...*

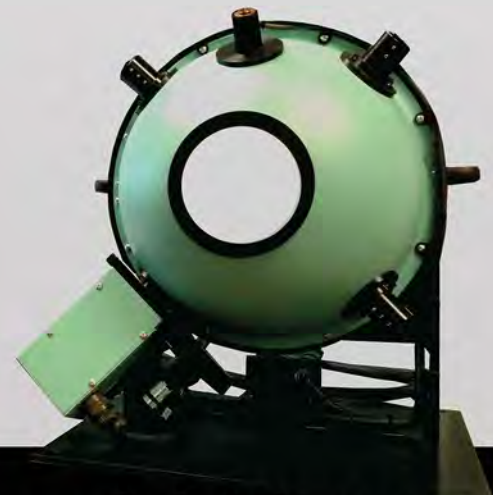

FURTHER READING

- [1] Steve Blank and Bob Dorf, *The Startup Owner's Manual: The Step-By-Step Guide for Building a Great Company Hardcover* (March 1, 2012) <https://steveblank.com>
- [2] Paul Millier, *Stratégie et marketing de l'innovation technologique* [Strategy and marketing of technological innovation], 3rd edn. (Dunod, Paris, 2011)
- [3] *Industrie 2.0, Jouer la rupture pour une renaissance de l'industrie française* [Industry 2.0: Changing direction for a revival of French industry] (Mc Kinsey France, 2013)

HOW CAN ATTOSECOND PULSE TRAIN INTERFEROMETRY

interrogate electron dynamics?

C.L. ARNOLD, M. ISINGER,
D. BUSTO, D. GUÉNOT,
S. NANDI, S. ZHONG,
J.M. DAHLSTRÖM,
M. GISSELBRECHT,
A. L'HUILLIER

Department of Physics,
Lund University, Lund, Sweden
cord.arnold@fysik.lth.se

Light pulses of sub-100 as ($1 \text{ as} = 10^{-18} \text{ s}$) duration, with photon energies in the extreme-ultraviolet (XUV) spectral domain, represent the shortest event in time ever made and controlled by human beings. Their first experimental observation in 2001 has opened the door to investigating the fundamental dynamics of the quantum world on the natural time scale for electrons in atoms, molecules and solids and marks the beginning of the scientific field now called attosecond science.

Attosecond light pulses cannot be obtained from a conventional laser, but result from a nonlinear interaction, when intense femtosecond laser pulses are focused into a dilute gas. It was observed in the late eighties that this interaction leads to the emission of a comb of odd-order harmonics of the driving laser [1,2]. Unexpected from the concepts of perturbative nonlinear optics, only the first few orders decrease exponentially in power, while higher orders form a plateau of almost equal power, until a sharp drop, called the cut-off,

is reached. Depending on the generation conditions, the cut-off can exceed 100 eV of photon energy, covering several tens of harmonics, and the effect was thus named high-order harmonic generation (HHG). It was soon realized that the comb of harmonics could correspond to a train of very short pulses, *i.e.* attosecond pulses, if the harmonics were phase-locked [3]. This view was inspired by a semi-classical model of the single-atom response in a strong driving laser field [4], which was shortly after also supported by a fully quantum mechanical treatment [5,6].

The semi-classical understanding of HHG, generally referred to as the three-step model, is illustrated in *Figure 1*. First, the atomic binding potential is so strongly distorted near the crests of the driving laser field that the least bound electron may tunnel-ionize to the continuum. Second, driven by the strong laser field, the electron is taken away from the parent-ion, picking up kinetic energy. Finally, when the driving field changes sign, the electron may return to its parent-ion and recombine, whereas its excess energy is emitted as an XUV photon. The kinetic energy of the returning electron depends on its trajectory, *i.e.* the path it takes from the time it was born in the continuum to its return to the parent-ion. Not all possible trajectories return to the parent-ion and contribute to HHG. The three-step process repeats itself for every half cycle of the driving field, resulting in an attosecond pulse train (APT). While the spectrum of each individual attosecond pulse in the train is continuous, the corresponding spectrum of the train results from the spectral interference of all pulses in the train and is composed of odd-order harmonics. This can be understood in analogy to the frequency comb structure

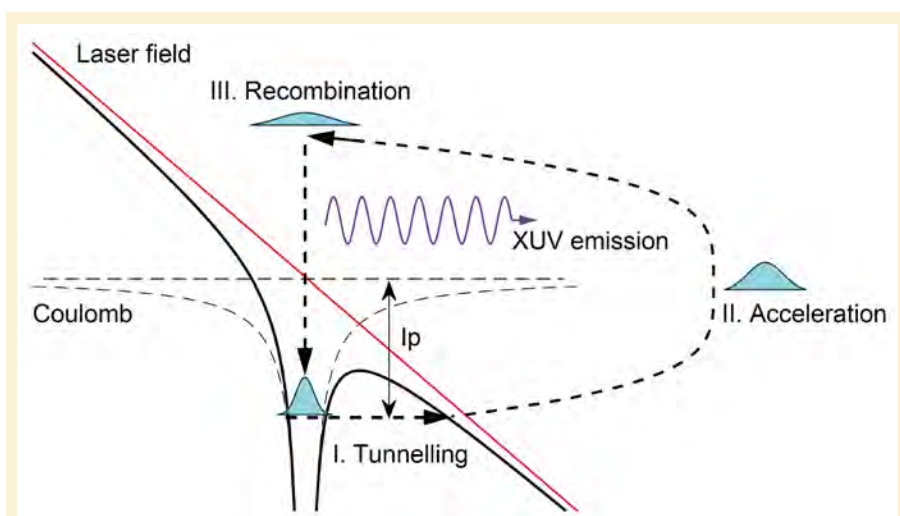

Figure 1. Illustration of the semi-classical three-step model for high-order harmonic generation.

of the output of an ultrafast oscillator, where the interference of the output pulses results in comb lines spaced by $1/f$, where f is the repetition rate of the oscillator. Single attosecond pulses (SAPs) can be obtained by spatially separating the pulses in the train [7,8] or by manipulating the driving pulse in a way that the interaction is driven by only one half-cycle of the field [9]. The conversion efficiency for HHG, *i.e.* the ratio of the energy of the attosecond pulse train or single attosecond pulse to the energy of the driving laser pulse, is about 10^{-5} at best (usually lower for single attosecond pulses and for photon energies larger than 50 eV), determined both by the single-atom response and by phase-matching in the generation gas. Still, modern attosecond pulse sources can have average powers in the range of μW to mW [10].

After the first observation of HHG, it took almost fifteen more years until the duration of attosecond pulses in a train as well as that of a single attosecond pulse were finally experimentally measured in 2001 [11,12]. The measurement approaches, *i.e.* RABBIT (Reconstruction of Attosecond Bursts by Interference of Two-photon Transitions) for APTs and the *Attosecond Streak Camera* for SAPs, are based on performing cross-correlations of the APT or SAP with a longer low-frequency pulse, usually a copy of the driving pulse for HHG, while the photoelectron spectrum originating from a detection gas as a result of the two fields is recorded. The spectral amplitude and phase of the APT or SAP are encoded in the photoelectron spectrum and the pulses can be retrieved with different computer algorithms.

The RABBIT technique for characterizing attosecond pulse trains

In this article, we will focus on the RABBIT technique and how it can be used to learn about fundamental electron dynamics on the attosecond

time scale. For that, we will first discuss the RABBIT scheme in more detail. The principle is illustrated in *Figure 2*. APTs synchronized with a weak copy of the driving pulse, in the following referred to as probe pulse, are sent into a photoelectron spectrometer, where photoelectrons are generated from a detection gas (usually noble gases), while the time delay between the APTs and the probe field is scanned with interferometric precision. Employing photoelectron spectroscopy for measuring attosecond pulses is somewhat obvious, taking into account that the photon energy generally overcomes the ionization potential of neutral gases. The underlying idea of RABBIT is to measure the phase difference between consecutive harmonics, which is the information needed to reconstruct the average attosecond pulse in the train. In optics, a phase difference is often assessed by interference. The different harmonics of the frequency comb representing an APT do however not result in a steady and observable interference, because they are separated in photon energy, so that the generated photoelectrons are also well separated in kinetic energy. The probe pulse however couples consecutive harmonics by introducing sidebands to the photoelectron spectrum, which are located between the harmonics. The sidebands are due to two-colour two-photon ionization; either a harmonic and a probe photon are absorbed simultaneously or a photon from the next harmonic is absorbed and a probe photon is emitted, resulting in two possible quantum paths from two consecutive harmonics to the same sideband, thus leading to interference. The sidebands oscillate with the time delay τ between the APT and the probe field as

$$S_{2q} = \alpha + \beta \cos[2\omega\tau - \Delta\phi_{2q} - \Delta\theta_{2q}], \quad (1)$$

where α and β describe the amplitude and contrast of the oscillations, respectively and $\Delta\phi_{2q} = \phi_{2q+1} - \phi_{2q-1}$ is the phase difference between the consecutive harmonics of the orders $2q+1$ and $2q-1$, where q is an integer.



SUPPLY
HIGH HARMONICS
GENERATION SOURCES
AND BEAMLINES

INTEGRATED DRIVING
BEAM ALIGNMENT
SYSTEM AND XUV
DIAGNOSTICS DEVICES

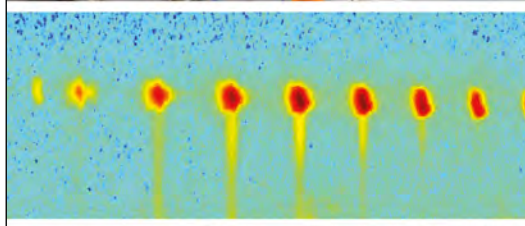
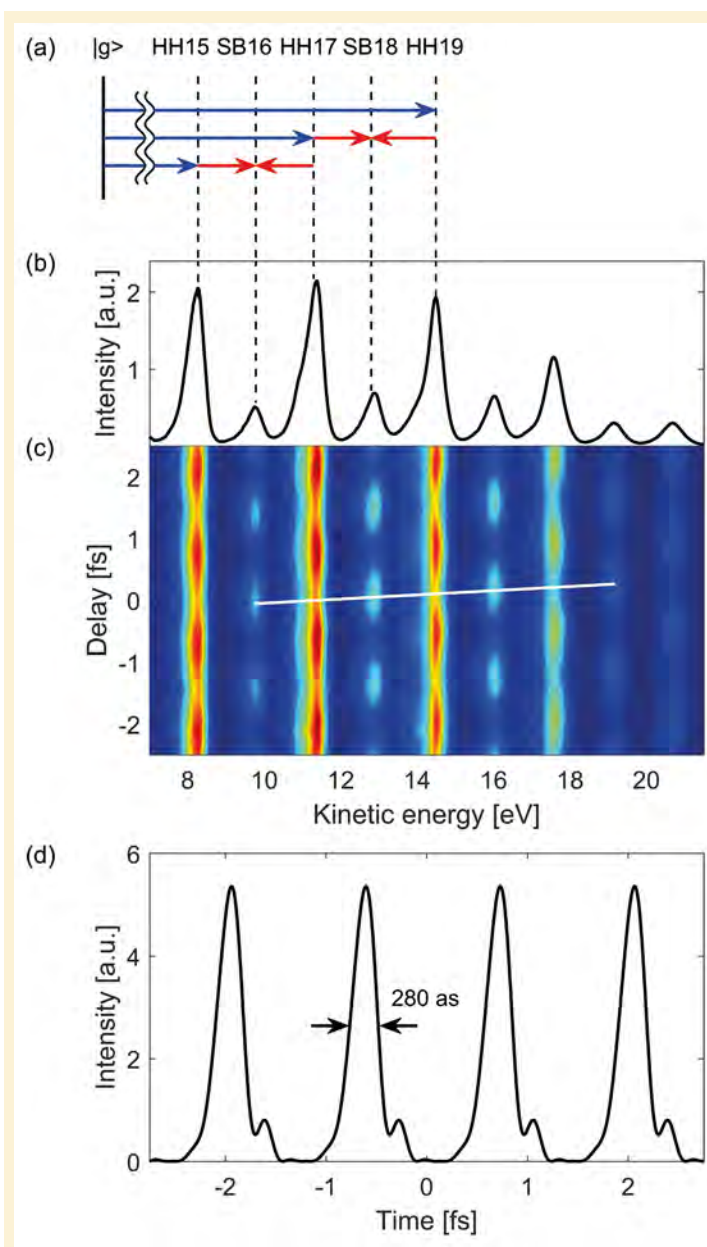

Figure 2. Illustration of the RABBIT technique. Panel (a) shows how two-colour (APT + probe) ionization leads to the formation of sidebands between the harmonics (blue) in the photoelectron spectrum plotted in (b). Panel (c) shows a RABBIT trace, *i.e.* photoelectron spectrum *vs.* delay between the APTs and probe pulses. The white line indicates the measured phase differences between harmonics, encoded in the sideband phases, which allow for reconstruction of the average pulse in the APT, as shown in (d).

The last term, $\Delta\phi_{2q}$, often referred to as atomic phase, is an intrinsic contribution from the detection gas due to two-colour ionization. If the phase differences between all consecutive harmonics are known, the average attosecond pulse in the train can be obtained by coherently adding the harmonics with their respective phase offsets. It should be noted that this is only accurate if the atomic contribution, *i.e.* $\Delta\phi_{2q}$, is small compared to the phase differences between the harmonics. Among many achievements, the RABBIT technique has shown that the intrinsic chirp of attosecond pulses, which

often is positive, can be compensated by transmission through thin metallic foils that provide anomalous dispersion in the XUV spectral range [13].

Investigating electronic dynamics on the attosecond time scale

While the early days of attosecond science were mostly dedicated to the characterization of the spectral and temporal properties of attosecond pulses, the focus has later shifted towards actually applying those pulses for studying dynamics on a

time scale that was not accessible before. One of the most prominent questions in this respect is “how long does ionization take?”, *i.e.* “how long does it take for a photoelectron to actually *leave* the atom after interacting with an attosecond pulse?” The contrary question, *i.e.* “how long would it take the parent-atom or molecule to know that it has been ionized and become an ion?” is equally intriguing. However, since the most prominent experimental tools of the field, *i.e.* streaking and RABBIT, inherently employ photoelectron spectroscopy, the leaving of a photoelectron is more straightforward to study. It should however be noted that the ionization time is a delicate quantity to define. After ionization, the photoelectron moves in the Coulombic potential of the ion, which changes with the inverse of the distance to the ion and formally reaches infinitely far; any definition of when the photoelectron has left the proximity of the ion would be somewhat arbitrary. What helps here, is a more fundamental quantum mechanical view on ionization, where we consider photoelectron wave packets of Coulombic waves instead of a classical particle-like understanding of photoelectrons. An electron wave packet is a quantum mechanical construction, describing the electron’s probability amplitude to be found in a certain position at a certain time. After ionization the photoelectron wave packet moves in the potential landscape of the ion. Similarly to an ultrashort laser pulse propagating in a dispersive medium, where the speed is a function of wavelength, the electron wave packet will pick up a group delay, which is defined as the derivative of its phase in respect to energy. While the Coulomb potential formally reaches infinitely far, the group delay of an electron wave packet propagating through it is finite. The acquired group delay can be interpreted as ionization time. This view was first introduced by Wigner for scattering events [14].



Delivering advanced solutions for fiber lasers from 0.8 to 2.1 μm .



Doped Fibers

- LMA & PM versions
- Advanced coating
- Matched passive fibers



FBG mirrors

- Custom profile
- High power handling
- Dissipative package



LiNbO₃ modulators

- Very low insertion loss
- Wide modulation bandwidth
- High extinction ratio



Modbox

- Sub-ns to longer optical pulses
- Pulse picker / Pulse Shaping / Front-End
- Turn-key and Optimized Solutions

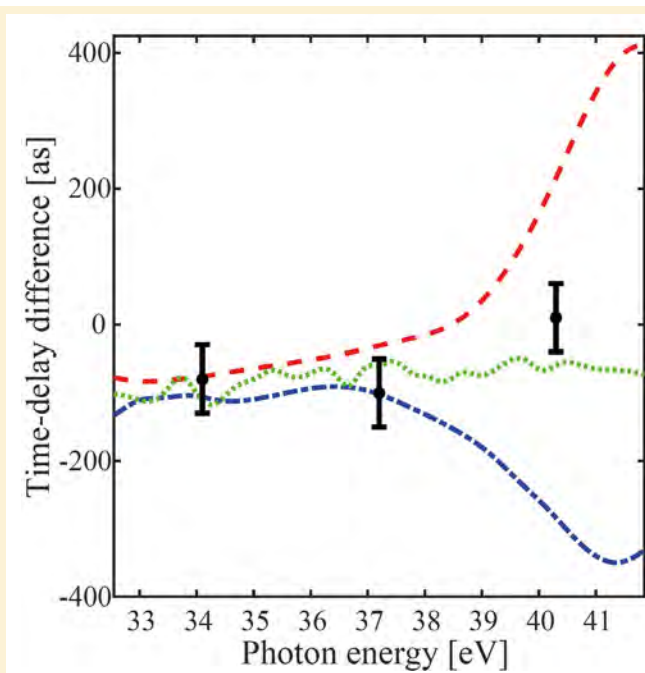

Figure 3. Measured relative ionization time delay between the 3s and 3p sub-shells in argon in comparison with different calculation methods. The figure is adapted from [18] with additional calculations from [19].

Determining the absolute ionization time however is complicated. Experiments have therefore mostly focused on measuring the *relative* time delay between photoelectron wave packets from different initial states, which is an easier question to answer than the absolute time delay. Prominent early examples of such experiments are the measurement of a relative time delay of about 100 as between the ionization from valence- and conduction band states in tungsten [15] as well as the relative time delay of 21 ± 5 as that was measured for ionization from the 2p sub-shell in neon as compared to the 2s sub-shell [16]. The latter work, further stimulated by the intriguing fact that the magnitude of the observed time delay could not be reproduced theoretically, has triggered a vast number of experimental and theoretical efforts to understand the origin of ionization time delays, and assessing such time delays became an important direction in attosecond science throughout the last few years.

While the pioneering experiments mentioned above were performed with the streaking technique, the first attosecond ionization time delays investigated with RABBIT were measured in the $n = 3$ shell in argon

[17,18]. The energy range around 40 eV that was investigated is particularly interesting because due to strong electron correlation effects, *i.e.* interactions between the different electrons of the atom, this energy region is difficult to treat theoretically. Thus, the measured difference in time delay can serve as qualitative indicator for the suitability of theoretical models. To illustrate how the RABBIT technique can be used to assess time delays, we shall rewrite equation 1 as

$$S_{2q} = \alpha + \beta \cos[2\omega(\tau - \tau_{2q} - \tau_\theta)], \quad (2)$$

where we express the phase differences as finite difference approximations of group delays, *i.e.* $\tau_{2q} = \left. \frac{\partial \phi}{\partial \Omega} \right|_{\Omega=2q\omega} \approx \frac{\Delta \phi_{2q}}{2\omega}$ and $\tau_\theta \approx \frac{\Delta \theta_{2q}}{2\omega}$, where ω is the carrier frequency of the laser pulses. In this view, the sideband oscillations described by equations 1 and 2, respectively can be interpreted differently. As ionization happens, the electron wave packet inherits the group delay of the harmonics, which explains one contribution to the phase of the RABBIT sidebands, *i.e.* the one corresponding to τ_{2q} . The other contribution, τ_θ , refers to a delay that the electron wave packet acquires in the potential

landscape of the ion in the presence of the probe field, where the contribution from the probe can often be determined theoretically [20]. While the contribution from τ_θ in the past was considered small, it has now moved into the focus for measuring photoionization time delays. However, determining absolute delays remains difficult since the absolute phase of a RABBIT sideband depends on the delay between the APT and the probe pulse, which usually is not known accurately enough. Thus, relative time delay measurements are performed. For example in the case of the photoionization in the $n = 3$ shell in argon, two RABBIT traces are recorded simultaneously for photoelectrons originating from the 3p and from the 3s sub-shells. As the photoelectrons are generated from identical attosecond pulses, any relative shift of the sidebands in the two RABBIT traces must originate from different group delays that the respective electron wave packets experience as a result of two-colour ionization. *Figure 3* shows measured relative time delays in comparison to different theoretical models. The different theories differ significantly around 40 eV and none of them shows perfect agreement with the measured delays.

It is fascinating to note that the relative time delays extracted from RABBIT traces are usually much smaller than the pulse duration of the attosecond pulses used in the measurement. The minimum observable delay is limited to how accurately the phase of the sidebands can be determined. This depends on the signal-to-noise ratio and the stability of the interferometer controlling the delay between the APTs and probe pulses rather than on the duration of the attosecond pulses. It is a very common feature of interferometric measurements, where often the phase of interferometric fringes can be determined with much greater accuracy than the wavelength of the light. One prominent example for this are gravitational wave detectors.

A proof-of-principle experiment performed in xenon showed that the RABBIT technique could be applied for more complicated ionization processes than those discussed so far [21]. In one-photon double-ionization, a single absorbed XUV photon leads to the ejection of two photoelectrons which share the excess energy continuously. The two electrons must thus interact with each other resulting in a time delay. Incorporating the ion into the picture, this is the prototype of the quantum mechanical three-body problem and therefore extremely interesting to study. However, recording a RABBIT trace in this case is much more challenging because the pairs of correlated photoelectrons must be measured in coincidence. This means, to be sure that two detected electrons originate from the same ionization event, one has to work at a rate of less than one event per laser shot, which makes recording RABBIT traces very time consuming and puts large demands on the laser's long-term stability. Comparing to single ionization from the $5p$ -shell, which is recorded simultaneously, the relative ionization time delay for the double-ionization process could be extracted [21]. Here, single ionization was used as a reference clock, because the absolute phase of RABBIT sidebands, as discussed earlier, is usually unknown.

Further developments

Since the first RABBIT measurements, femtosecond laser technology has evolved rapidly. One interesting aspect of that development is spectral tunability. Employing tunability of the carrier wavelength of the driving pulses for HHG, the high-order harmonics are no longer fixed at specific photon energies. If one harmonic is tuned through a resonance, the phase of that resonance will be carried into the sidebands above and below that harmonic. The respective next sidebands will however be unaffected and can serve as reference to extract the phase associated with the resonance. This technique was applied to study the phase in two-colour two-photon ionization of helium [22] and more recently to measure the phase evolution of a Fano resonance in argon [23]. Fano resonances are a very general phenomenon in physics, characterized by an asymmetric line shape that originates from the interference between a resonant process and a background [24]; in atomic systems, between direct photoionization to the continuum and excitation to a quasi-bound state above the ionization potential, which will rapidly decay (within femtoseconds) to the

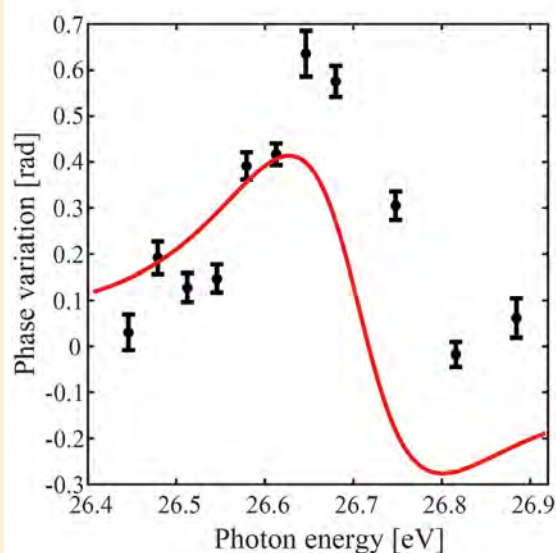
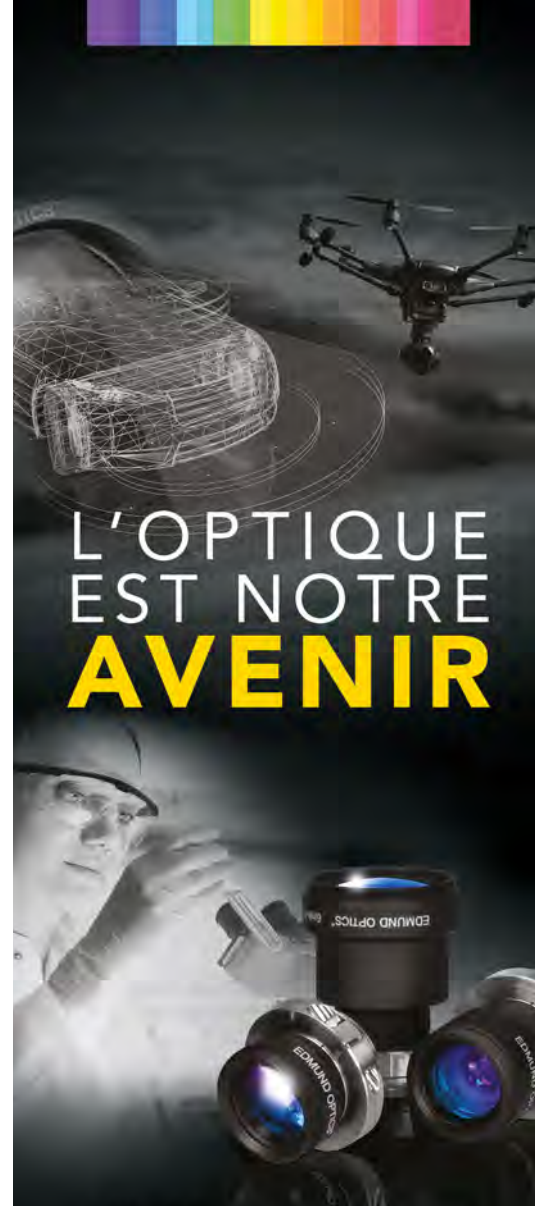

Figure 4. Phase variation of sideband 16 plotted against the photon energy of harmonic 17, which is scanned through the Fano resonance. The black circles are the measurement and the red line shows calculations. The figure is adapted from [23].



L'OPTIQUE est une technologie habilitante, car elle rend possible plusieurs applications dans la fabrication avancée, la communication, la protection et la sécurité, les technologies numériques, l'énergie, la médecine, ainsi que les tests et mesures. Chez Edmund Optics®, nous visons à **RENDRE L'AVENIR POSSIBLE** en nous concentrant sur l'avancement de tous les aspects de la vie et en surmontant les limites technologiques avec l'imagerie.

Pour en savoir plus
www.edmundoptics.fr/future

► Rendez-nous visite :

24 - 27 Avril 2018
Hall 4, Stand 4411

22 - 26 Avril 2018
Stand G524



SPIE PHOTONICS EUROPE

+33 (0) 8 20 20 75 55
sales@edmundoptics.fr

eo Edmund optics | worldwide

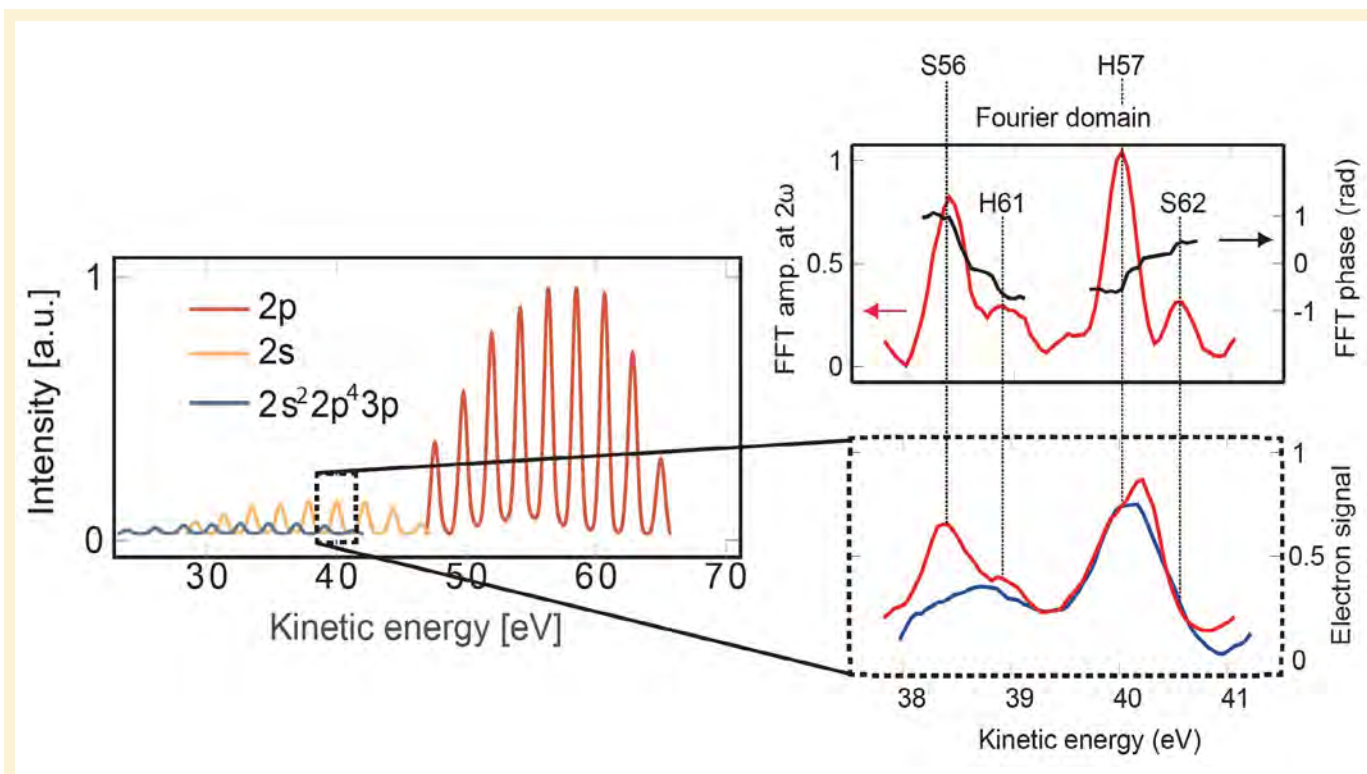

Figure 5. Illustration of the spectrally resolved RABBIT sideband analysis applied in [27]. The left graph shows simulated photoelectron spectra, obtained for attosecond pulse trains generated with 800 nm driving pulses, from the $2p$ sub-shell in neon (red line, ionization potential 21.6 eV), from the $2s$ sub-shell (yellow line, ionization potential 48 eV) and from ionization with shake-up (blue line, ionization potential 55.8 eV). The photoelectrons due to shake-up ionization lie between the ones from the $2s$ sub-shell and would thus overlap with $2s$ sidebands in a RABBIT measurement. The right side of the figure shows the photoelectron kinetic energy region around harmonic 57 and sideband 56 of the $2s$ sub-shell. The lower plot shows the measured photoelectron spectrum for APTs only (blue line) and APTs+probe (red line), clearly visualizing the spectral overlap of sideband 56 with photoelectrons coming from ionization with shake up by absorption of harmonic 61. The upper plot shows the oscillation amplitude (red line) and extracted phase (black line), obtained from Fourier analysis. Only the low energy part of sideband 56 (which is free from overlap) can be used to retrieve the sideband phase.

continuum, *i.e.* auto-ionize. In the experiment, a Fano resonance in argon is spectrally scanned with harmonic 17 of a 800 nm driving pulse. The phase of the resonance is imprinted on the adjacent sidebands and can be extracted using a sideband unaffected by the resonance as reference. The experimentally obtained phase is shown in *Figure 4*. This gives a characterization of the electron wave packet in amplitude and phase, which *e.g.* in the case of helium with a single continuum channel can be used to analyse it in the time-frequency domain [25,26] similarly to what is done in ultrafast optics for ultra-short optical pulses, and provides intriguing complementary information to the spectral domain investigations extensively performed in the past.

Conclusion

To conclude our article, we would like to focus on a very recent result. Enabled by more reliable and long-term stable lasers as well as more efficient and high-resolution photoelectron spectrometers, the signal-to-noise ratio in RABBIT measurements can be increased to a level that spectral information can now often be obtained by directly analysing the sideband phase energy-resolved instead of averaging it over the whole width of the sideband [26]. This approach has helped to resolve the long-standing mystery of the $2s/2p$ relative ionization delay in neon [27]. One condition for a RABBIT measurement to work properly is that the sidebands are not overlapping spectrally with

any other states, which would lead to a wrong phase retrieval of the sideband. In the RABBIT traces recorded for photoelectrons from the $2s$ and $2p$ sub-shells in neon in [27], the $2s$ sidebands were overlapping with peaks due to $2p$ ionization with shake up of another $2p$ state to the $3p$ state, *i.e.* an ionization event where due to electron-electron interactions the ion is left in an excited state. However, the correct phase of the sideband could be obtained by only using the spectral interval where the sideband was free from overlap. Using this technique, relative ionization time delays between the $2s$ and $2p$ sub-shells in neon were obtained, now in excellent agreement with theory [27]. The energy-resolved sideband analysis is illustrated in *Figure 5*.

The probably most exciting aspect of the techniques discussed in this article is the ability to measure amplitude and phase of electron wave packets and by that have full access to the temporal dynamics on the attosecond time scale. Modern laser technology in combination with high-resolution photoelectron spectrometers provide high temporal and energy resolution, opening the door to measurements on more complicated systems like molecules or nano-structures. Furthermore, laser technology currently pushes the development of HHG attosecond sources with higher photon energy in the range of hundreds of electron-volts. After almost two decades of studying mostly valence shell dynamics, attosecond science is now well prepared to also put its focus on the rich dynamics of the inner atomic shells. ■

FURTHER READING

- [1] A. McPherson *et al.*, *J. Opt. Soc. Am. B* **4**, 595 (1987)
- [2] M. Ferray *et al.*, *J. Phys. B* **21**, 31 (1988)
- [3] P. Antoine *et al.*, *Phys. Rev. Lett.* **77**, 1234 (1996)
- [4] P.B. Corkum, *Phys. Rev. Lett.* **71**, 1994 (1993)
- [5] K.J. Schafer *et al.*, *Phys. Rev. Lett.* **70**, 1599 (1993)
- [6] M. Lewenstein *et al.*, *Phys. Rev. A* **49**, 2117 (1994)
- [7] H. Vincenti *et al.*, *Phys. Rev. Lett.* **108**, 113904 (2012)
- [8] C.M. Heyl *et al.*, *New J. Phys.* **16**, 1367 (2014)
- [9] F. Calegari *et al.*, *J. Phys. B: At. Mol. Opt. Phys.* **45**, 074002 (2012)
- [10] C.M. Heyl *et al.*, *J. Phys. B: At. Mol. Opt. Phys.* **50**, 013001 (2017)
- [11] P.M. Paul *et al.*, *Science* **292**, 1689 (2001)
- [12] M. Hentschel *et al.*, *Nature* **414**, 509 (2001)
- [13] R. López-Martens *et al.*, *Phys. Rev. Lett.* **94**, 033001 (2005)
- [14] E.P. Wigner, *Phys. Rev.* **98**, 145 (1955)
- [15] A.L. Cavalieri *et al.*, *Nature* **449**, 1029 (2007)
- [16] M. Schultze *et al.*, *Science* **328**, 1658 (2010)
- [17] K. Klünder *et al.*, *Phys. Rev. Lett.* **106**, 143002 (2011)
- [18] D. Guénot *et al.*, *Phys. Rev. A* **85**, 053424 (2012)
- [19] M. Magrakvelidze *et al.*, *Phys. Rev. A* **91**, 063415 (2015)
- [20] J.M. Dahlström *et al.*, *Chem. Phys.* **414**, 53 (2013)
- [21] E.P. Månsson *et al.*, *Nature Phys.* **10**, 207 (2014)
- [22] M. Swoboda *et al.*, *Phys. Rev. Lett.* **104**, 103003 (2010)
- [23] M. Kotur *et al.*, *Nature Comm.* **7**, 10566 (2016)
- [24] U. Fano, *Phys. Rev.* **124**, 1866 (1961)
- [25] D. Busto *et al.*, *J. Phys. B* **51**, 044002 (2018)
- [26] V. Gruson *et al.*, *Science* **354**, 313 (2016)
- [27] M. Isinger *et al.*, *Science* **358**, 893 (2017)

Fibertech Lille (France)

Fibertech Lille is a high technology research center based in the IRCICA institute in Lille (France). It is devoted to the design/fabrication of industry-standard passive and active optical fibers as well as state-of-the-art specialty optical fibers for research purposes. This platform gathers several original facilities dedicated to the fabrication of preforms by MCVD (Modified Chemical Vapor Deposition), OVD (Outside Vapor Deposition), Sol-GeL and powder processes as well as an area dedicated to develop original chemical precursors, allowing to address a large variety of dopants (Yb, Er, Bi, gold nanoparticles...) and glass geometries. Two-sided fiber drawing tower is available (12 m high) permitting the fabrication of any kind of state of the art silica optical fibers (spun fibers, photonic crystal fibers, hollow core fibers, large mode area fibers, rare-earth doped fibers, few mode fibers, multicore fibers...), with uniform or longitudinally-controlled profiles (tapers or topographic fibers). In addition, the platform is equipped with facilities for the characterization of fiber or preforms (preform index profiler, electronic microscope, OTDR, dispersion/nonlinearity measurement platforms, modal content with S² method), the post processing and the functionalizing of optical fibers (e.g. writing of long fiber Bragg gratings or fabrication of specific beam combiners or mode adapters for high-power fiber laser systems). *Fibertech Lille* is composed of leading experts in the design/fabrication and implementation of complex optical fibers in lightwave systems for pure research

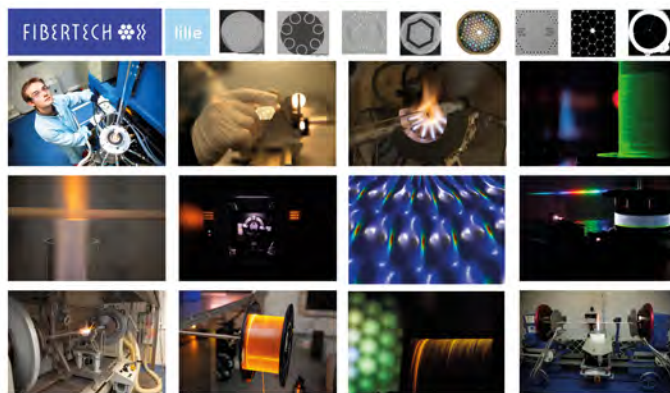

or applications-oriented purposes. The platform is driven by the photonics group (PHLAM laboratory, University of Lille) which main research interests are on fiber optics telecommunications, biophotonics, nonlinear optics (theory and experiments), fiber laser sources development in close collaboration with academic and industrial partners from all over the world. All these aspects make *Fibertech Lille* one of the leading expert in fiber optics in Europe. ■

CONTACT

FIBERTECH LILLE

Géraud Bouwmans, Fibertech Lille leader,
geraud.bouwmans@univ-lille1.fr
 Arnaud Mussot, Photonics Group leader,
arnaud.mussot@univ-lille1.fr
<http://fibertech.univ-lille.fr/presentation>

LIGHTING: A DRIVER OF *the sustainable revolution*

Harry VERHAAR

Philips Lighting, The Netherlands
harry.verhaar@philips.com

Some of the most important things in life are taken for granted, and nowhere is this truer than with light. In this article, we will look at some important milestones marking light's path from human evolution to sustainable revolution, challenges facing the modern lighting industry as well as the world we live in, and what the future promises. In a sense, a new revolution is at hand. It would be hard to overestimate the fundamental importance of light as it shapes virtually everything we sense and experience.

If we look at the history of lighting, antiquity offers important events that moved the technology of fire-light forward, such as the oil lamp circa 4500BC, or the candle 1500 years later. But if we look to the science of light itself, it was in 1015 that Persian scholar Ibn al-Haythem (often referred to as the father of modern optics) published his *Book of Optics*, a seven volume treatise that described light as a phenomenon of wavelengths being received by the human eye and processed by the brain.

Many others have built on these early discoveries. In 1815 French engineer and physicist Augustin-Jean Fresnel extended the wave theory of light to a larger class of optics. In 1865, with the

publication of *A Dynamical Theory of the Electromagnetic Field*, Scottish scientist James Clerk Maxwell demonstrated the wave properties of electrical and magnetic fields, and proposed that electricity, magnetism and light are different manifestations of the same wave-based phenomenon. As the wave light theory became generally accepted, Albert Einstein took a slightly different approach, describing in 1905 how light can also behave as particles, or photons. Through the centuries, many of our brightest scientific minds have worked to better understand the properties of light, and these discoveries have fueled the many technological advances to follow.

The first revolution: electric light in the home and workplace

What can be considered the first revolution in lighting was the successful introduction, a little more than a century ago, of so-called "artificial" or electric light into the home and workspace. This leap forward was made possible by the convergence of two distinct technologies: widespread electrification and the invention of a long-lasting carbon filament lamp. Early carbon filament bulbs had a lifespan of 40 hours, while further refinements in filament composition increased lifespan dramatically. The first central power plant in the United States — became operational on September 4, 1882, serving an initial load of 400 lamps and 82 customers in a one-quarter square mile area. Only two years later, the station served more than 500 customers and powered more than 10 000 lamps. The world's demand for more light and the power needed to generate it has grown exponentially in the years since.

In the quest for a more efficient technology, several families of gas discharge bulb were created including the fluorescent lamp. Fluorescent lighting came to be widely used in office and industry lighting applications because of its energy efficiency in relation to light output as compared to



Meydan Bridge, Dubai.

incandescent lamps. Compact fluorescent lamps (CFL) were later developed to replace incandescent lamps in the home. Additionally, high intensity discharge (HID) lamps, utilizing an electrical arc between tungsten electrodes mounted in a gas medium, built upon the earlier technology of the simple arc lamp to deliver more visible light per unit of electricity than either incandescent or fluorescent lamps before them. This family of lamp types is used primarily for outdoor applications such as the lighting of streets, stadiums, and retail locations.

Undoubtedly, the most promising technology to transform electric lighting in recent decades has been the development of the LED, or light emitting diode, a format in which voltage is applied to a two-lead semiconductor triggering the release of energy – in this case illumination – in the form of photons. The lifespan and electrical efficiency of the LED lamp is several times greater than any of the technologies that have preceded it, offering tremendous benefits in terms of energy savings. In fact, the promise and potential of global adoption of LED lighting comes at a crucial point in human history.

The challenges at hand

When Thomas Edison threw the switch at Pearl Street Station in 1882, he directed about 600 kilowatts of electricity. Today, 7 billion citizens demand more than 20 trillion kilowatts. By 2050, with a population approaching 9.5 billion, demand could double. By that point, it is possible we could face a gap between energy supply and demand which some call the “zone of uncertainty”. Beyond growth in population and energy demand, a variety of factors call for disruption in the lighting industry. One is increased urbanization: today 54% of the world population, 3.5 billion people, live in cities. By 2050, it is projected that over two thirds, or close to an additional 3 billion, will be urban residents. Simultaneously, an additional 3 billion will become part of the middle class, increasing their energy use accordingly. By 2030 these global



Solar-LED lighting enabling children to study and make their homework in the evening.

trends will already lead to an estimated 35% increase in the number of light points worldwide.

Underlying these already formidable challenges of growth, the realities of climate change force an urgent collective focus on reducing energy consumption and carbon emissions. Realizing the opportunity for the savings afforded by LED, on December 7, 2006, Philips took an unprecedented action in the lighting industry by calling for a global phase-out of incandescent light bulbs, the very basis and origin of the company. Governments around the world followed it. In 2009, the European Union initiated a phase-out of incandescent bulbs which was completed by 2012. In the subsequent years the lighting market transition has turned into a global LED lighting revolution.

A second revolution: the promise of LED

The promise of LED is profound, in part due to the alignment of two distinct technologies. Just as the incandescent lamp was integrated into the growing footprint of electrification more than a century ago, today the integration of connected LED technology into the Internet of Things means lighting need no longer be thought of as a matter of output but of outcomes. In the years ahead, continued advances in connected, user-centric lighting will transform the way we live, work, travel, relax, light our cities, grow our crops, heal the sick, and much more.

As a value proposition, even with the formidable growth in light points by 2030, LED offers huge savings in terms of both cost of operations, and toll on the environment. In 2006 – the

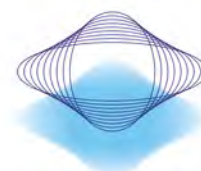

Fichou

CAPABILITIES

YOUR PARTNER TO MEET YOUR UNIQUE NEED.

FICHOU OFFERS THE IDEAL KNOWLEDGE OF **CUSTOM OPTIC MANUFACTURE** ASSOCIATED WITH **CUSTOM OPTICAL COATING DESIGN** TO MEET YOUR NEEDS.



PRODUCTS

- CUBE , PRISM, MIRROR
- WAVEPLATE, POLARIZER
- LENS, BEAMSPLITTER,
- WINDOW, ...
- CRYSTAL, ROD, ...



COATINGS

- ANTIREFLECTION COATING
- DIELECTRIC COATING
- METALLIC COATING
- INFRARED COATING
- CUSTOMIZED COATING



CUSTOM REALIZATIONS

- PYRAMID
- LARGE SAPPHIRE WINDOW
- POLARIZATION OPTICS
- POLARIZATION SCRAMBLER
- WAVEPLATE 150 MM DIAMETER
- ACHROMATIC RETARDATION PLATE



Certificated by AECMA EASE in accordance of EN9100
www.optique-fichou.com
 Fichou : 11 rue Louise Bourgeois, 94260 Fresnes FRANCE

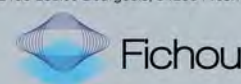

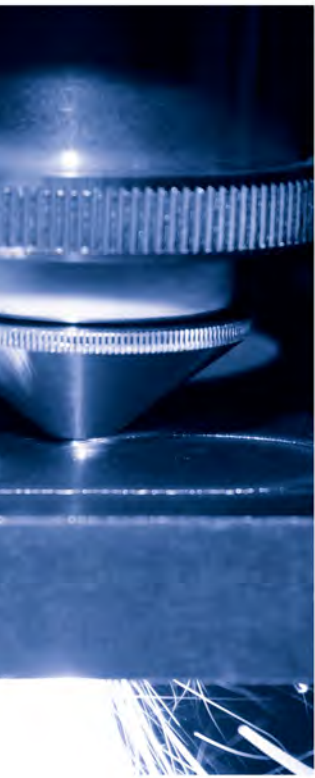

LEADING & INNOVATING IN THE GLOBAL ECONOMY

Our multiple **R&D**, **manufacturing**, **sales** and **service** locations in Europe deliver laser-based solutions of superior reliability and performance for a wide range of customers worldwide.

Materials Processing to Life Sciences, Microelectronics to Scientific Research –
Global Reach. Local Focus – coherent.com/excellence





Citytouch connected LED lighting across the city of Los Angeles.

last year the lighting market was changing at an evolutionary pace – lighting accounted for 19% of global electricity consumption. A universal switch to LED lighting would reduce this proportion to around 8%, curbing global carbon dioxide emissions by about 1400 megatons by 2030.

Beyond energy efficiency, cost savings and reduced carbon emissions, LED offers tremendous benefits to our quality of life. LED can now be used in all applications, connected to lighting management systems and adjusted to produce new lighting experiences. The following examples highlight the advantages of positioning connected LED technology within the Internet of Things while giving an exciting glimpse of things to come.

Connected cities

The City of Los Angeles's public lighting system includes almost a quarter of a million streetlights – more than any other city in the U.S. Given that streets comprise fully 15% of the city's total area, it is no surprise that Los Angeles is known the world over as a driving city. But Mayor Eric Garcetti is determined to make Los Angeles a walking city as well. In 2015, he launched a Great Streets Initiative to revitalize neighborhoods by making the streets more pedestrian-friendly, and new street lighting technology that can ensure better and more reliable lighting operations was an important part of the plan.

In 2015, Los Angeles reported an energy saving of 63% and a cost reduction of almost \$9 million. The city offers a compelling model for the potential of connected street lights to deliver better, more energy efficient light.

Connected offices

The office space of the 21st century is rapidly evolving, and lighting plays a vital role in this transformation. A vivid example can be found in the Edge, an innovative, 40 000 square meter, multi-tenant office building in the Zuidas business district in Amsterdam. Philips Lighting worked closely with OVG Real Estate, the building's designer, and Deloitte, it's primary tenant, to deliver a connected lighting system that enhances the flexibility of the open-plan office, where workers have no fixed desk, but rather utilize a variety of shared spaces from sitting desks, standing desks, meeting rooms or private enclosures. It is what the Dutch call *het nieuwe werken*: the new way of working.

Beyond increasing comfort and productivity, the system also provides building managers with real-time data on operations and activities. Edge managers use the software to visualize and analyze this data, track energy consumption and streamline maintenance operations. This provides for maximum efficiency as well as a reduction of the building's CO₂ footprint. The expected savings for the Edge are € 100 000 in energy costs and € 1.5 million in space utilization costs per year.

imagine  optic™

Wavefront sensors and adaptive optics for optical metrology, lasers and microscopy



Optical metrology applications



Adaptive optics for laser beam control



Solutions for X/EUV applications

Contact us for more details:
contact@imagine-optic.com
or +33 1 64 86 15 60

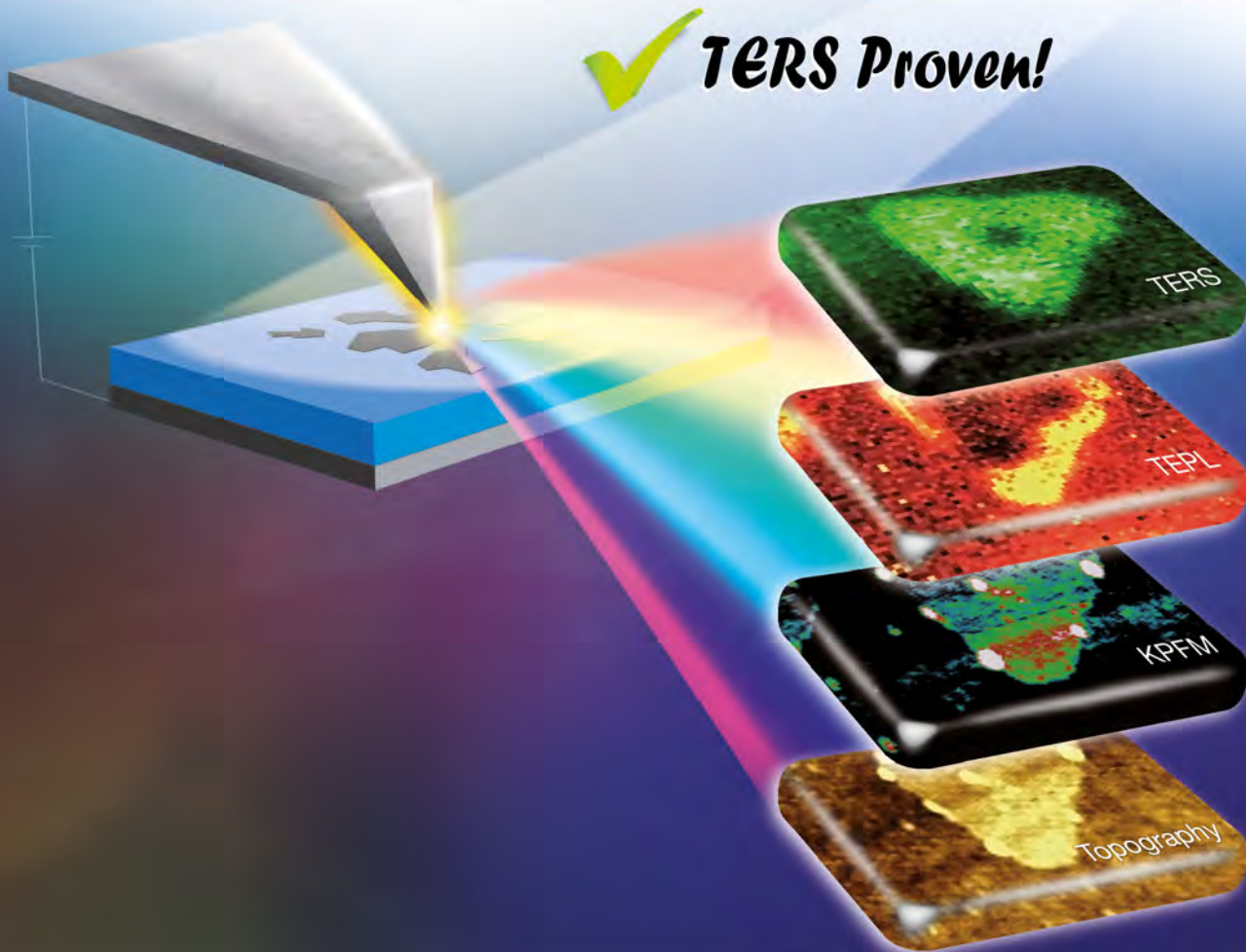

NanoRaman™: When Atomic Force Microscopy Integrates Optical Spectroscopy

- ✓ Multi technique analysis platform from macro to nanoscale
- ✓ True Confocal Raman spectroscopy
- ✓ Robust, stable, ultimate resolution in AFM
- ✓ Multi-user friendly, short time to results



www.horiba.com/nanoraman | info-sci.fr@horiba.com



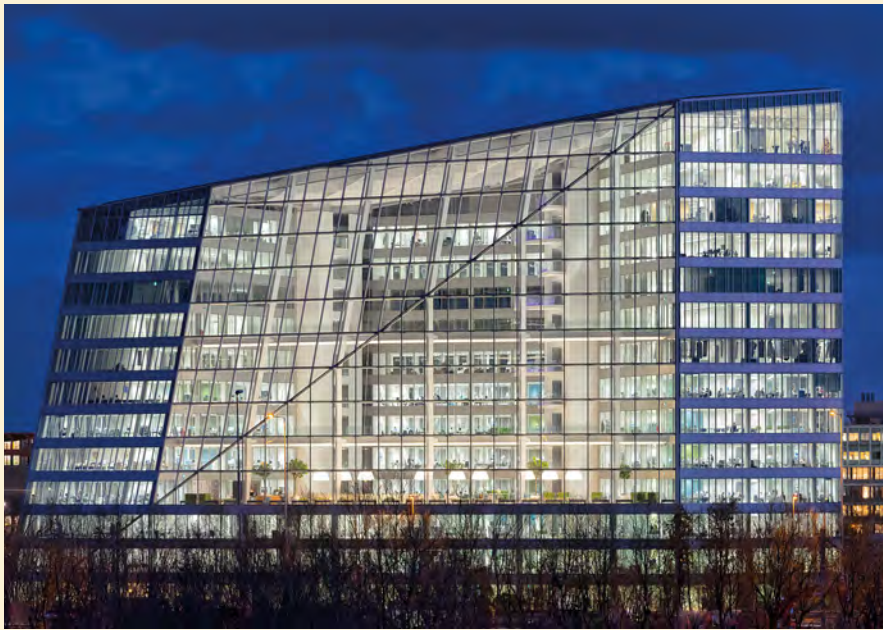

The Edge, Amsterdam, the greenest and most intelligent building in the world.

YOUR PARTNER
IN LASER & OPTICS
DEVELOPMENT
AND INNOVATION

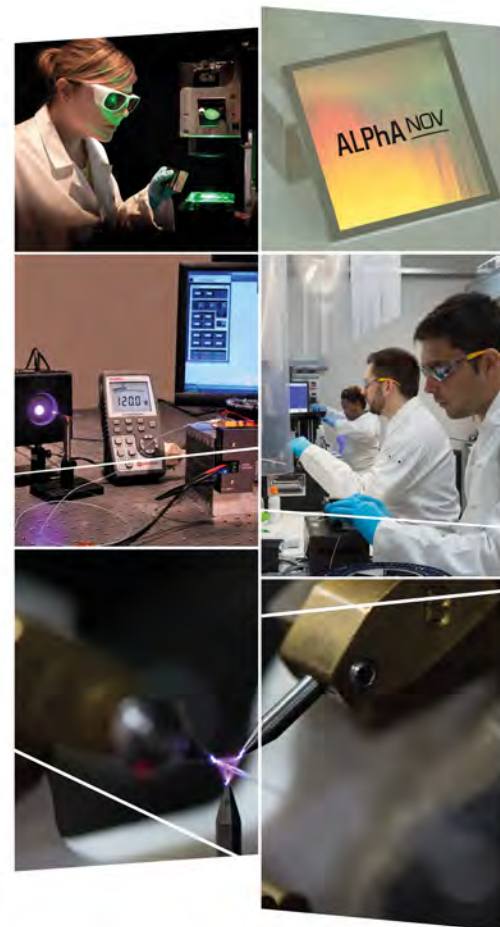

- ☐ LASER PROCESSING & MICRO-MACHINING
- ☐ LASER & OPTICAL SYSTEMS
- ☐ LASER SOURCES & FIBER COMPONENTS
- ☐ PHOTONICS FOR HEALTH PURPOSES

Connected homes

Lighting is one of the main interests in the Internet of Things for the home. Philips Hue was the world’s first connected lighting system for the home when it launched in 2012, and has since become the system of choice for consumers.

Connected LED technology allows light to be an interactive part of the home environment. With more than 16 million colors to enhance any atmosphere, light recipes can be designed to help users feel more energized in the morning or more relaxed after a busy day.

Eliminating light poverty

As governments across the world look for ways to curb carbon emissions, improving energy efficiency is an urgent priority. In developing regions, solar lighting has given us huge opportunities to “leapfrog” outdated technology. Off-grid solar lighting is an important tool in driving down carbon emissions and accelerating global development. We don’t have to wait for answers or new inventions. The technology we need is already transforming the lives of off-grid and urban communities in India.

Something more than illumination

From the capturing of fire as a tool, through technical advances that are transforming electric light into something more than illumination, lighting has undergone a dramatic evolution and seen equally dramatic periods of revolution. In fact, revolution is again in the air. In the years to come we will see the complete disappearance of the 19th century incandescent light bulb – the end of the first mass electrical appliance – to be replaced by 21st century connected LED lighting systems and technology. Through ceaseless innovation and a commitment to the opportunities these breakthroughs afford, a new revolution is at hand: an era of more and better light – light that provides for a more sustainable world. ■

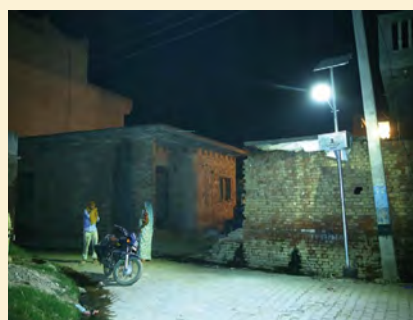

Uttar Pradesh, solar-LED streetlighting.

GOLD NANOPARTICLES as nanosources of heat

Guillaume BAFFOU
Institut Fresnel, CNRS,
Aix Marseille Univ,
Centrale Marseille,
Marseille, France
guillaume.baffou@fresnel.fr

Under illumination at their plasmonic resonance wavelength, gold nanoparticles can absorb incident light and turn into efficient nanosources of heat remotely controllable by light. This fundamental scheme is at the basis of an active field of research coined thermoplasmonics and encompasses numerous applications in physics, chemistry and biology at the micro and nano scales.

Heat generation in plasmonics

When a metal nanoparticle is illuminated, its free electrons oscillate at the frequency of the electric field of the incoming light. This electronic oscillation is responsible for a re-radiation of light, an important feature of metal nanoparticles, but it also means an electronic current in a metal, which naturally gives rise to heat generation via Joule effect. This photothermal effect can be further enhanced when shining the nanoparticle at its plasmonic resonance wavelength. This resonance occurs, *e.g.*, around 500 nm for gold nanospheres, but it can be red-shifted by engineering the morphology of the nanoparticles, which makes the beauty of the field of research called plasmonics. Gold demonstrated many benefits compared to other plasmonic materials. It features unequalled photothermal efficiencies, the plasmonic resonance can be shifted

in the infrared (ideal for biomedical applications) and chemical functionalization of gold is easy. For these reasons, almost all the applications involving heat generation in plasmonics have been based on the use of *gold* nanoparticles. *Figure 1a* illustrates the principle of gold nanoparticle heating using light.

For a long time, heat generation in plasmonics was considered as a side effect that had to be minimized in regards to the optical effects like light scattering or, more importantly, optical near-field enhancement. It was only in 2002 that some important conceptual ideas were proposed, the most famous one being the possibility to cure cancer (see further on). Then, the community realized that heating on the nanoscale could yield countless applications, with some imagination. That time corresponds to the birth of thermoplasmonics [1,2], a still rapidly growing field of research today.

The main challenge: measuring nanoparticles' temperature

Heating gold nanoparticles is straightforward, one just needs to shine them with light. The challenge is not here. The real difficulty rather consists in controlling the temperature increase. Probing temperature on the micro and nano scales is not simple. When thermoplasmonics was born, in the early 2000s, temperature probing on the nanoscale was mainly the job of scanning thermal microscopy (SThM). This technique consists in using a nanometric thermocouple at the apex of a tip and scan it over a sample. But this approach would have been very invasive to measure the temperature of nanoparticles. For this reason, other techniques had to be invented.

Most of the temperature microscopy techniques for plasmonics have

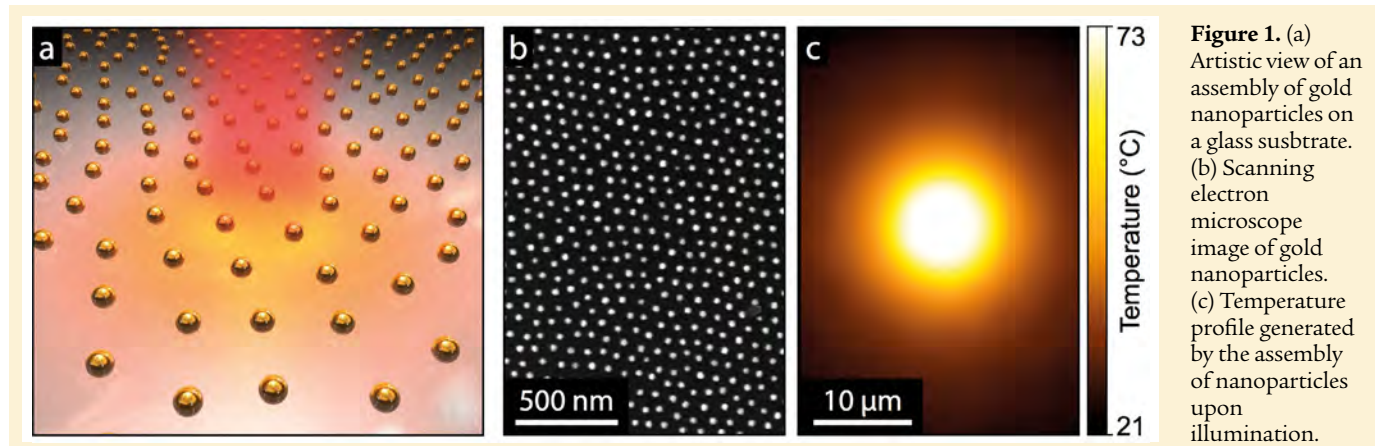

Figure 1. (a) Artistic view of an assembly of gold nanoparticles on a glass substrate. (b) Scanning electron microscope image of gold nanoparticles. (c) Temperature profile generated by the assembly of nanoparticles upon illumination.

been developed since 2009 and most of them are based on fluorescence measurements [4]. Since most fluorescence properties depend on temperature (intensity, spectrum, excited-state life time, polarization anisotropy), it becomes possible to disperse fluorescent molecules at the vicinity of metal nanoparticles and then map the fluorescence in order to map the temperature, provided a calibration law was previously determined. But this kind of technique implies a modification of the sample, and fluorescence properties are not only dependent on temperature, which may yield artefacts. Some other thermal measurement techniques have thus been developed based on Raman spectroscopy, refractive index variations, infrared radiation, X-ray absorption spectroscopy, microwave spectroscopy of nanodiamonds, etc. Today, the panel of temperature mapping techniques is very large and enables a more accurate use of plasmonic nanoparticles as nanosources of heat compared to a decade ago. *Figure 1b-c* gives an example of a temperature measurement performed

on gold nanoparticles using a label-free microscopy technique based on quantitative wavefront sensing.

This large panel of techniques, involving a large variety of physical processes, illustrates an important aspect of thermoplasmonics: the multidisciplinary. Working in thermoplasmonics usually implies working at the interface between different fields of Science as detailed in the next section.

The countless temperature-induced effects in science

Almost any field of science features some thermal-induced effects. Thus, almost any field of science can be addressed on the nanoscale, with a new glance, to hopefully uncover new applications, when using plasmonic nanoparticles as nanosources of heat. This is why the field of thermoplasmonics has been very active this last decade, motivating researchers from physics, chemistry and biology working at the interface between nanooptics and thermodynamics.

More precisely, as soon as a nanoparticle is heated, subsequent processes can occur in the surrounding environment, such as nanobubble formation, stress wave generation, enhancement of chemical reactions, microscale fluid convection, enhanced Brownian motion, liquid superheating (i.e., heating above the boiling point of a liquid without boiling), thermal radiation, microscale thermophoresis of colloids and biomolecules, modification of the metabolism of living cells. All these processes have been at the basis of research studies and recent applications, as described in the next section.

Cancer therapy and other promising applications

Photothermal cancer therapy was one of the first proposed application involving plasmonic nanoparticle heating. In 2003, two different groups led by Jennifer L. West and Charles P. Lin concomitantly proposed to internalize gold nanoparticles in tumors and

YOU DECIDE WHAT'S NEXT!

APP YOUR SENSOR®!

IDS:NXT

powered by **HALCON**



Visit Yokogawa at SPIE Photonics Europe 2018 at stand S506, Strasbourg, France

An OSA for every application

Trusted instruments for world class optical performance

There is an AQ6370 series Optical Spectrum Analyser (OSA) which satisfies your specific measurement needs in the range from visible light to mid-infrared (350 to 3400 nm).

- The highest wavelength resolution: up to 10 pm
- The widest measurement power range: up to 110 dB
- The highest sensitivity: down to -90 dBm
- An unmatched close-in dynamic range: up to 78 dB
- The free space optical input

For your specific application, contact us now and get a demo in your lab.

tmi.yokogawa.com
tmi@nl.yokogawa.com
+31884641429

Precision Making



subsequently shine an infrared laser to heat the nanoparticles and burn the tumor [3]. As biologists have the ability to achieve specific binding of nanoparticles to cancer cells, this approach can yield the specific destruction of the cancer cells, and not of the healthy surrounding cells and tissues, at least in theory. The principle of this application is depicted in *Figure 2*. Many investigations have been conducted on the level of cells in culture or living mice endowed with subcutaneous tumors. In 2010, a start-up was built, named Nanospectra, aimed at carrying out clinical trials. 7 years later, the results have not been disseminated yet. Several difficulties may indeed limit the applicability of this technique: first, the difficulty to control and to measure the temperature distribution in tissues. Temperatures up to 46 °C have to be achieved in the whole tumor location; while lower temperatures would result in a partial destruction of the tumor, which is not desired; and higher temperatures may be hazardous in the presence of vital organs in the vicinity of the treated volume. Second, human body is not transparent. Using infrared light helps going deeper compared to visible light, but it still remains difficult to go beyond 1 cm, making it difficult to treat some types of cancers. Interestingly, photothermal therapy does not only consist in treating cancer

and gold nanoparticle heating has been used recently to treat other pathologies, such as atheroma or acne, with very good efficiencies.

Photoacoustic imaging is a biomedical imaging modality based on the photoacoustic effect, which consists of the emission of acoustic waves following a local and rapid absorption of a light pulse by efficient light absorbers such as blood vessels, tumors, melanin, dyes, etc. By collecting the sound waves following a pulse of light using a set of acoustoelectric transducers, it is possible to reconstruct in three dimensions the morphology of the absorbing medium. First proofs of concept date from the early 80s. The idea to use gold nanoparticles as contrast agents in photoacoustic imaging came later, in 2001. The benefits of using gold nanoparticles are two-fold: (i) gold nanoparticles are excellent photothermal contrast agents and their absorption can be tuned in the near-infrared, *i.e.* in the biological transparency window, allowing deep imaging in tissues. (ii) It allows imaging of specific targets, like a tumor, by active targeting of the nanoparticles conjugated with antibodies that will specifically attach to the region of interest. This way, regions characterized by weak endogenous photothermal contrast can be made visible for photoacoustic imaging thanks to the use of gold nanoparticles. Gold nanoparticles were

injected intravenously a couple of hours prior to imaging. Since 2010, most of the efforts have been devoted to find more efficient metallic nanoparticles by playing with the nanoparticle morphology or nature, and expanding the range of applications of plasmon-assisted photoacoustic imaging, from cancer diagnosis to imaging of atherosclerotic plaques, brain function and image-guided therapy.

Nanochemistry depicts the generation of chemical reactions involving a nanometric spatial scale, either because the products are, for instance, nanoparticles or because the chemical reaction occurs at a nanometric scale. This second picture matches an application of plasmonic nanoparticles in nanochemistry. As most chemical reactions are catalyzed by heating, according to the Arrhenius law, gold nanoparticles as nanosources of heat can be used to very locally enhance a chemical reaction, even at the nanoscale. The interest of such an approach is three-fold. (i) Heating at the nanoscale makes it possible to achieve very fast thermal dynamics due to a reduced thermal inertia (the smaller the heated volume, the faster the heating and subsequent cooling). (ii) Heating a reduced volume makes it possible to superheat a liquid reaction medium above its boiling point, without boiling, opening the path for solvothermal chemistry at

Unmatched Positioning Performance



Three-dimensional vector accuracy error measured in the Z=0 mm XY plane

HexGen® Hexapods by Aerotech... The next-generation in 6 degree-of-freedom positioning

HexGen® hexapods are ideal for large payload, high-speed, ultra-precise positioning. The HEX500-350HL provides unmatched positioning accuracy ($\pm 0.5 \mu\text{m}$ linear, $\pm 2.5 \mu\text{rad}$ angular) and positioning resolution (20 nm linear, 0.2 μrad angular). Simply stated, HexGen hexapods are the highest performance hexapods on the market.

Contact an Aerotech application engineer or visit our website for more information on how Aerotech hexapods can improve your positioning application.



www.aerotech.com
+33 2 37 21 87 65

AT0118A-RAD-FR

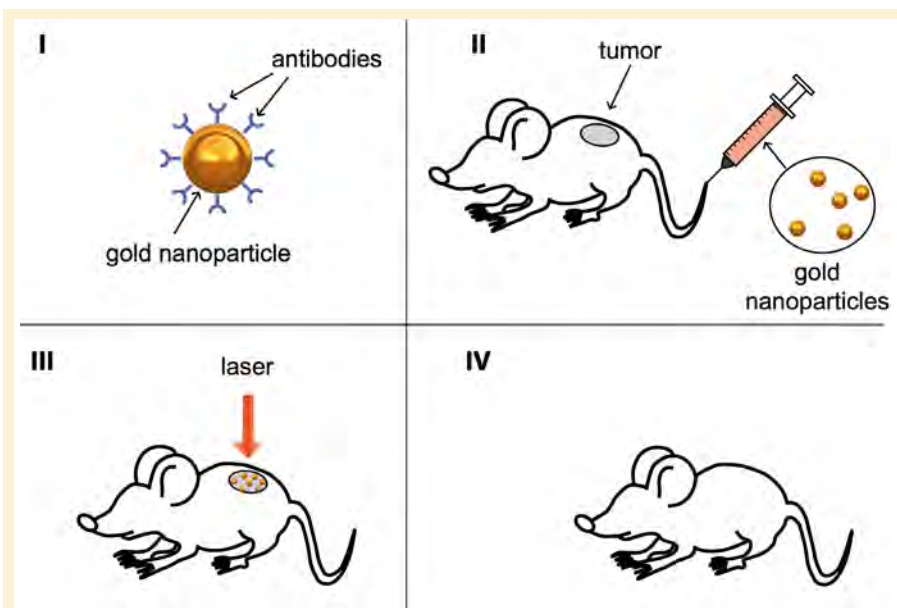

Figure 2. Process of photothermal therapy illustrated on a mouse. (a) Schematic of a nanoparticles coated with antibodies associated to specific receptors of the membrane of cancer cells. (b) Tail-injection of a gold nanoparticle solution in a mouse endowed with a sub-cutaneous tumor. (c) Laser heating of the tumor, once the nanoparticles are agglomerated in the cancer cells. (d) After several treatments, the tumor is destroyed.

ambient pressure. (iii) Heating at the nanoscale enables the formation of products with a nanometric spatial resolution, opening the path for original lithography techniques. Applications of plasmonics in nanochemistry do not only involve photothermal effects. Plasmonic nanoparticles under illumination can also act as efficient light enhancers at the nanoscale, favouring photochemical reactions at their vicinity, and efficient sources of hot electrons, catalyzing redox processes with a nanoscale spatial resolution.

Photothermal imaging is based on the probing of local variations of refractive indices produced by optical heating of an absorbing medium. In 2002, Michel Orrit's team introduced the use of nanoparticles as efficient photothermal contrast agents [5]. Nanoparticles as small as a few nanometers, normally invisible using standard optical microscopes because too small, can be made visible upon heating because a much larger volume surrounding the nanoparticles exhibits a variation of its refractive index. This seminal achievement gave birth to a novel label-free imaging technique in biology. While fluorescent tags used in cell biology tend to rapidly photobleach

during imaging, gold nanoparticles can live (almost) forever. If attached to, *e.g.*, membrane proteins, the diffusion of the proteins in the membrane can be followed during hours, which provides valuable and additional information compared to a fluorescent labelling that could not be used for long acquisitions due to photobleaching.

What's next?

Interestingly, new developments in thermoplasmonics are still being proposed by the community, even 15 years after the birth of the thematic. There exist three recent and promising research thematic that are worth mentioning here and that should animate a large community in the next decade. First, *gold* has been the candidate of choice for most applications in thermoplasmonics. But its

low-temperature melting point prevents from using it in high-temperature applications. For this reason, the community is currently looking for other possible plasmonic materials that would exhibit equivalent or better properties, but which would sustain much higher temperature increases. For the time being, no better material has been confidently found, but one may expect new discoveries in the near future, presumably by using metal alloys merging the benefits of different materials. Second, gold nanoparticles have been recently used to induce thermophoresis at the microscale. Thermophoresis denotes the motion of molecules or colloids induced by a temperature gradient in fluids. Although the origins of *thermophoresis* in liquids are still an active matter of debate, several applications have already been developed. Recently, Frank Cichos's team managed to advantageously use gold nanoparticles under illumination to create retroactive thermophoretic traps capable of confining the motion of biomolecules under the field of view of a microscope [5]. Third, more and more experiments are reported involving the plasmonic heating of living cells in culture. The state of a living cell is highly dependent on the temperature. Studying the effect of temperature on living cells may imply bulky apparatus, based on resistive heating of the sample holder, characterized by a large thermal inertia. Heating cells using gold nanoparticles and a laser beam offers important advantages. (i) Heating dynamics can be as fast as approximately 1 ms, which enables the study of very fast thermally induced processes in cells. (ii) One cell at a time can be heated, or even subcellular compartments, opening the path for new kinds of fundamental research in single cell thermal biology and thermogenetics. ■

FURTHER READING

- [1] G. Baffou, *Thermoplasmonics* (Cambridge University Press, 2017)
- [2] G. Baffou, R. Quidant, Thermoplasmonics: using metallic nanostructures as nanosources of heat, *Laser and Photonics Reviews* **7**, 171 (2013)
- [3] P.K. Jain, I.H. El-Sayed, M.A. El-Sayed, Au nanoparticles target cancer, *Nano Today* **2**, 18 (2007)
- [4] D. Jaque, F. Vetrone, Luminescence nanothermometry, *Nanoscale* **4**, 4301 (2012)
- [5] D. Boyer, P. Tamarat, A. Maali, B. Lounis, M. Orrit, Photothermal imaging of nanometer-sized metal particles among scatterers, *Science* **297**, 1160 (2002)



Lasers solutions beyond limits

The new KEOPSYS - QUANTEL group provides high-end laser solutions based on 3 main technologies, diodes, solid-state lasers and fiber lasers, to provide solutions to applications in demanding sectors like medical equipment, defense, and sensing for scientific and industrial use.

As an example of these applications, QUANTEL proposes its new diode module for photoacoustic imaging.

The final portable photoacoustic/ultrasound imaging system will be used for diagnosis of cardiovascular disease, arthritis and skin cancer.



In the new group, KEOPSYS focuses on fiber laser solutions. The product range includes CW fiber lasers for biotechnologies, like DNA sequencing, or medical treatments in ophthalmology, like laser surgery for glaucoma.

With its new ELBA laser, which has been integrated in ISO 13485-certified devices, KEOPSYS can provide a wide variety of spectral lengths with very narrow bandwidth.

Another emerging application is automotive LiDAR for ADAS (Advanced Driver Assistance Systems). Vehicle manufacturers are looking for sensors, capable of detecting any obstacle over 200 m in front of a moving vehicle. A 1,55 μm fiber laser solution is both eye-safe and provides the required solution in terms of performance, integration and price. For that type of application, KEOPSYS is proposing the KULT laser, the most integrated pulsed eye-safe fiber laser of the market.



Thanks to all its technology, and its new modular platform concept, the QUANTEL-KEOPSYS group is the perfect laser partner to imagine new applications beyond current limits. ■

CONTACT

QUANTEL-KEOPSYS

2 bis, avenue du Pacifique - 91941 Les Ulis Cedex, France
Tel: + 33 (0) 1 69 29 17 00

www.quantel-laser.com - www.keopsys.com
quantel@quantel-laser.com - websales@keopsys.com

KEOPSYS / QUANTEL

A NEW GROUP WITH LASERS FOR INNOVATIVE APPLICATIONS

CW & pulsed fiber amplifiers



Pulsed Nd:YAG lasers



CW & pulsed fiber lasers



Laser diodes

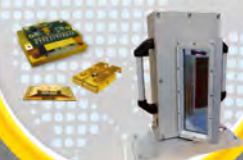

www.keopsys.com



www.quantel-laser.com

KEOPSYS and QUANTEL are merging for an innovative laser future

RETINAL PROSTHESIS SYSTEM: a revolutionary advancement for the severely visually impaired

Second Sight Medical Products
EPFL - Innovation Park A,
CH-1015 Lausanne
www.secondsight.com

Despite all the advancements in modern ophthalmology, disease can affect vision, resulting in blindness. Worldwide, there are 200 000 people who have retinitis pigmentosa, 2 million with age-related macular degeneration (AMD) and 6 million have other forms of sight loss.

Since the 1990s, epiretinal implants have been developed to electronically stimulate the retinas of blind people, restoring a certain amount of visual function in patients who have sight loss, therefore helping to improve their independence and quality of life. The common factor between these systems is that they comprise of a multi-electrode matrix, forming the core of the stimulator, which is placed as close as possible to the retina. This matrix emits electrical impulses that stimulate the remaining live nerve cells, which are present on the retina.

Of the epiretinal implants available, some use a camera and calculate the sequences of the stimulation impulses in an external video processor.

This is the case for the system developed by EPIRET, who is proposing a telemetric retinal implant, fully implanted in the eye. This device includes 25 electrodes mounted on a flexible polyamide film, and connected via an intraocular cable to an impulse

generator and to a receiving module integrated into an intraocular lens, on the edge of which a take-up spool is mounted.

This is also the case for the Argus II system, developed by SecondSight (www.secondsight.com), and which incorporates a retinal prosthesis and an external device (glasses, a camera, a video processing unit and a cable). The retinal prosthesis is surgically implanted inside and around the eye. The prosthesis includes an aerial, an electronics module and an electrode array. A tiny video camera is fitted to the patient's glasses. The images captured by the camera are sent to a small computer (the video processing unit), worn by the patient. The processed images are then sent to the glasses via a cable, then sent wirelessly to an aerial contained in the retinal implant.

The signals are then sent to an electronics module, housed in the retinal implant, which are then converted into tiny electronic impulses on the

electrodes. The impulses emitted stimulate the cells in the retina, which in turn, transmit the visual information to the optic nerve (using the normal process used to perceive images), thus creating the perception of illuminated shapes in the brain.

Patients therefore receive the sensation of light via the eye, with the image being transferred to the brain. They learn to interpret these visual shapes, thus regaining a certain level of visual function: perception of shapes, movements, objects and large letters.

Results obtained

The objective of the retinal prosthesis is to provide the person with better vision than they would have had before receiving the retinal prosthesis system. Generally, the system also provides patients with:

- an improvement in their orientation and mobility: they can follow the edge of a pavement and the lines of a pedestrian crossing, avoid obstacles, find doors and windows in a room, their plate on a table, etc.
- more awareness of people around them, being able to see someone who is approaching them or moving away from them,
- more independence: being able to perform everyday tasks, visit family and friends, go to restaurants, etc.
- a renewed social life, and improved wellbeing and quality of life.

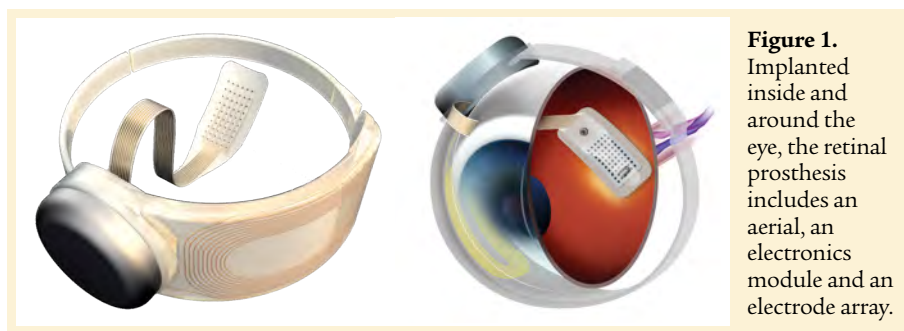

Figure 1. Implanted inside and around the eye, the retinal prosthesis includes an aerial, an electronics module and an electrode array.



Figure 2. The external equipment includes glasses, a camera, a video processing unit (VPU) and a cable.

Results have generally been observed from the first few days post surgery: patients are capable of visualizing a square light on a black screen. After several weeks of exercises, patients can, for example, follow a white line on the ground. After several months, they can differentiate between letters and detect people's outlines.

Currently, nearly 260 patients around the world are fitted with an Argus II device, due to collaborations between large ophthalmological surgery centers. In France, the device is available at three centers of excellence, validated for implantation into patients with retinitis pigmentosa: the Quinze-Vingts National Ophthalmological Hospital Center in Paris, the Reference Center for Rare Genetic Ophthalmological Diseases in Strasbourg and the ophthalmological department at Bordeaux

University Hospital. Beyond France and the United States, the Argus II is also available at approved centers in Canada, Germany, Austria, Italy, The Netherlands, Saudi Arabia, Spain, Switzerland, Turkey, the United Kingdom, Taiwan, Russia and South Korea.

Future developments

Researchers and engineers are currently working on improving the retinal prosthesis system, and expanding the number of diseases that could benefit, for example, in the treatment of patients with a less advanced stage of retinitis pigmentosa. Notably, the study has shown that the more residual vision the patients have, the less their retina is disorganized, and the more consistent the benefits provided by this technology are.

Another study is investigating the benefits of retinal stimulation in patients with age-related macular degeneration (AMD). This study is of particular interest: on the one hand, due to the fact that there are lots of patients with this condition (twenty times more than those with retinitis pigmentosa), and on the other, because these patients have some residual peripheral vision (and in this situation, integration has been observed between the peripheral vision and the central vision produced by the retinal implant).

Furthermore, a clinical trial is about to start with an even more revolutionary system, which will directly activate the visual cortex (therefore, on the surface of the brain). The objective: to create vision directly within the visual centers of the brain. The hope is that this system will be able to help people with conditions other than those treated with the current retinal implants (diseases that affect the eye, the optic nerve or the visual pathways, following a trauma for example).

Furthermore, through the software (so, *without* the risk of a surgical procedure), studies are working towards increasing the number of pixels created in patients, to improve the clarity and detail of the vision, and thus create a more natural visual experience. ■

International Masters Programmes

The University Bourgogne Franche-Comté is now accepting enrolment enquiries for its Masters Degree programmes in its new International Graduate School (EIPHI). In particular, a Master in Photonics and Applied Physics is offered at the UBFC Besançon Campus, and a Master in Physics, Photonics & Nanotechnology at the UBFC Dijon campus. These 2 year programmes provide state-of-the-art training in photonics, micro and nano technologies, quantum optics & quantum information processing, time-frequency metrology, information theory and complex systems. The Masters will prepare students for careers in industry or for PhD studies. Courses are in

English, and are open to students with a suitable undergraduate degree. The Masters are supported by the FEMTO-ST Institute and the ICB Laboratory, research institutions with major international reputations. The towns of Dijon and Besançon have excellent quality of life, rich university atmospheres, and ready access to cultural and outdoor pursuits. For information and links to the application form see: www.ubfc.fr/formationen. Formal applications are open from 23 April-23 June 2018. Enquiries at any time can be directed to Prof Stephane Guerin sguerin@u-bourgogne.fr (Dijon) or Maxime Jacquot maxime.jacquot@univ-fcomte.fr (Besançon).

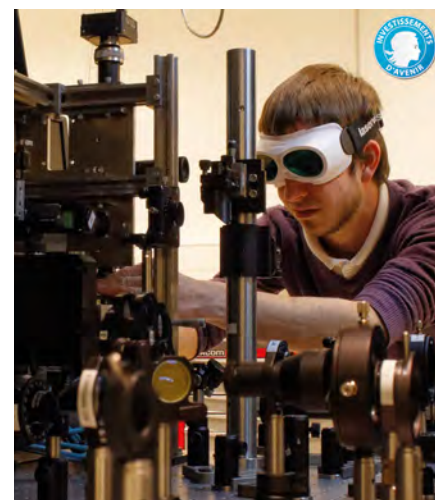

BACK TO BASICS: History of photonic crystals and metamaterials

Costas M. SOUKOULIS^{1,2}

¹ Ames Laboratory and Department of Physics, Iowa State University, Ames, Iowa, USA

² Institute of Electronic Structure & Laser (IESL), FORTH, Heraklion, Crete, Greece
soukoulis@ameslab.gov

We will review the history of photonic crystals and overview of the theoretical and experimental efforts in obtaining a photonic bandgap, a frequency band in three-dimensional dielectric structures in which electromagnetic (EM) waves are forbidden, is presented. Many experimental groups all over the world still employ this woodpile structure to fabricate PCs at optical wavelengths, waveguides, enhance nanocavities, and produce nanolasers with a low threshold limit. We have been focused on a new class of materials, the so-called metamaterials (MMs) or negative-index materials, which exhibit highly unusual electromagnetic properties and hold promise for new device applications. Metamaterials can be designed to exhibit both electric and magnetic resonances that can be separately tuned to occur in frequency bands from megahertz to terahertz frequencies, and hope-fully to the visible region of the EM spectrum.

Novel artificial materials (photonic crystals (PCs), MMs, nonlinear optical MMs, optical MMs containing gain media, graphene, chiral optical MMs and plasmonics) enable the realization of innovative electromagnetic (EM) properties unattainable in naturally existing materials. These materials, characterized here as MMs, have been in the foreground of scientific interest in the last ten years. There has been a truly amazing amount of innovation during the last few years and more is yet to come. Clearly, the field of PCs and MMs can develop breaking technologies for a plethora of applications, where control over light is a prominent ingredient – among them telecommunications, solar energy harvesting, biological and THz imaging and sensing, optical isolators, nanolasers, quantum emitters, wave sensors, switching and polarizers, and medical diagnostics.

However, many serious obstacles must be overcome before the impressive possibilities of MMs, especially in the optical regime, become real applications.

History of photonic crystals: from diamond to woodpile structures

Shortly after the introduction of the concept of photonic band-gap (PBG) materials [1,2], our group at Iowa State/Ames Lab discovered the first diamond PBG structure that can exhibit a complete 3D photonic gap [1,2]. Complete gaps were found in the two diamond structures. However, this diamond dielectric structure is not easy to fabricate, especially at the micron and submicron length for infrared or optical devices. Therefore, it is important to find new periodic structures that possess full photonic gaps, but,

at the same time, are easier to fabricate (see Fig. 1). We thus modified the

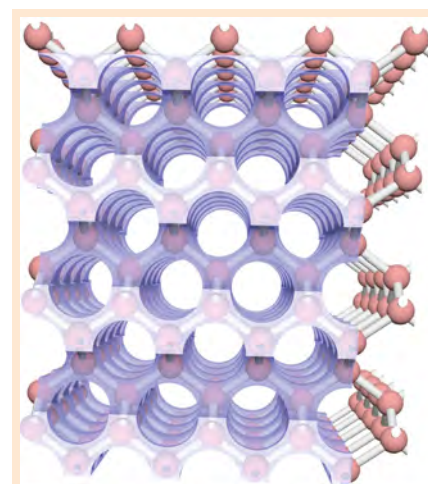
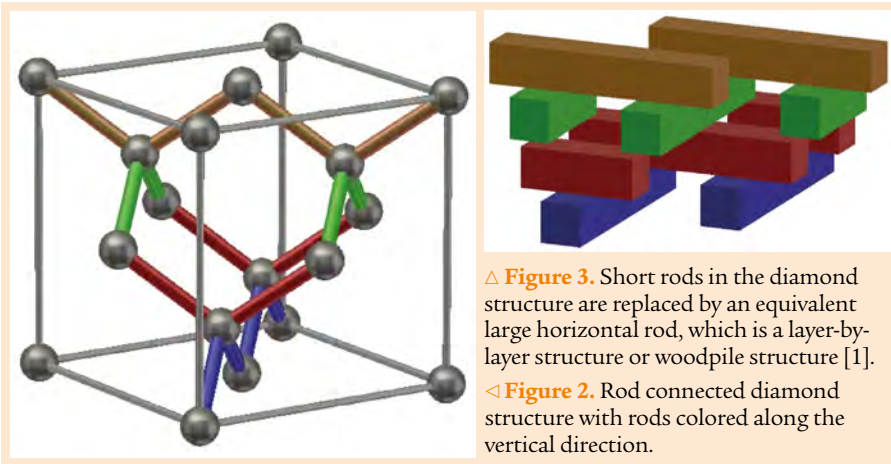

Figure 1. A “ball and the stick” model of the diamond structure, viewed from an angle such that the channels along a [110] direction are observable. Shrinking the size of the “balls”, while keeping the “sticks” and “3-cylinder” diamond structure with “air-cylinder”.



△ **Figure 3.** Short rods in the diamond structure are replaced by an equivalent large horizontal rod, which is a layer-by-layer structure or woodpile structure [1].

◀ **Figure 2.** Rod connected diamond structure with rods colored along the vertical direction.

bandgaps. Many experimental groups around the world still use the woodpile structure to fabricate photonic crystals at optical wavelengths. These designs have been instrumental in bringing forward the revolutionary fields of photonic crystals [1-2], negative diffraction, and metamaterials [4-5], extending the realm of electromagnetics while opening exciting new applications.

History of metamaterials: from microwaves to optics structures

Microwave metamaterials

Our group at Armes Lab demonstrated negative refraction properly designed PCs in the microwave regime and also demonstrated sub-wavelength resolution of $\lambda/3$. We fabricated a left-handed material (LHM) with the highest negative-index transmission peak corresponding to a loss of only 0.3 dB/cm at 4 GHz frequencies. We established that split-ring resonators (SRR) also have a resonant electric response, in addition to their magnetic response. The SRR electric response is cut-wire like and can be demonstrated by closing the gaps of the SRRs, thus destroying the magnetic response. We studied both theoretically and experimentally the transmission properties of a lattice of SRRs for different incident polarizations.

diamond structure to obtain other photonic crystal structures easier to fabricate—hence, the introduction of a layer-by-layer (or woodpile) version of diamond. *Figure 2* shows the rod-connected diamond structure with rods colored along the [100] vertical direction. *Figure 3* presents the woodpile design – short rods in the diamond structure are replaced by an equivalent large horizontal rod.

The layer-by-layer (woodpile) structure was first fabricated in the microwave regime by stacking alumina cylinders that demonstrated a full 3D photonic bandgap at 12-14 GHz. We fabricated this woodpile structure and demonstrated a full 3D photonic bandgap at 100 and 500 GHz. The woodpile structure was then fabricated by microelectronic fabrication technology (see *Fig. 4*) and operated at

infrared wavelengths. Structures made by advanced silicon processing [3] and wafer fusion techniques operate at near-infrared wavelengths. It also was fabricated by direct laser writing to operate at infrared and near-infrared wavelengths. Inverse woodpile PCs made from silicon by CMOS-compatible deep reactive-ion etching were the first nanostructures to reveal spontaneous emission inhibition. In another approach, “3-cylinder” photonic crystals were fabricated by a deep X-ray lithography technique in polymers (see *Fig. 5*) and the transmission spectra show a 3D photonic bandgap centered at 125 μm (2.4 THz) in good agreement with theoretical calculations.

These photonic crystal designs (diamond lattice [1,2] and the woodpile structure [3], respectively) provided the largest completed 3D photonic

Fast Multi-Channel Photonics Alignment System



FAST AND NANOSCALE-ACCURATE ALIGNMENT OF OPTICAL FIBERS
IN TESTING AND PACKAGING PROCESSES

Double-sided, 6-axis hexapod aligners with 3-D piezo scanner

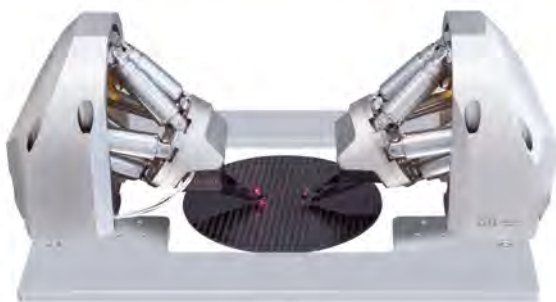

NanoCube® piezo-based alignment engine



Fast and high-precision miniature hexapod

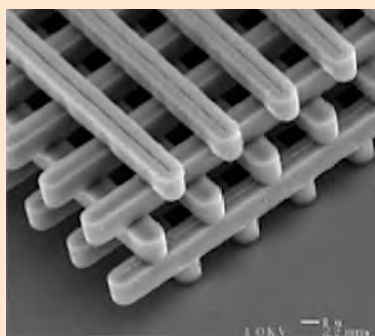

Figure 4. Electron-microscope image of a “woodpile” photonic crystal made by silicon with a complete band gap at 12 μm [1].

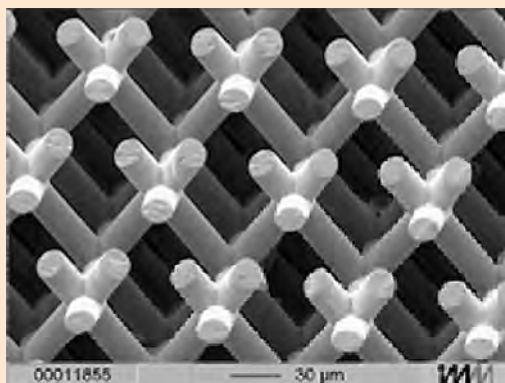

Figure 5. The “three-cylinder” photonic crystal made from negative tone resist [1].

We showed that as one decreases the size of the SRR, the scaling breaks down and the operation frequency saturates at some value. We will come back to this important point below. We suggested a new 3D left-handed material design that gives an isotropic negative index of refraction. This design has not been fabricated yet. We introduced new designs that were fabricated and tested at GHz frequencies. These new designs were very useful in fabricating negative-index materials at THz and optical wavelengths

and can be easily measured for perpendicular propagation. A simple unifying circuit approach offered clear intuitive as well as quantitative guidance for the design and optimization of negative-index optical metamaterials

Optical metamaterials

In the optical transmission experiments on very small samples, we took advantage of the fact that, loosely speaking, one can couple to the

magnetic-dipole resonance via the magnetic field of the light and via the electric field. The latter can be accomplished under normal incidence of light with respect to the substrate – which was much easier for these early experiments. We varied the lattice constant, opened and closed the slit and thereby unambiguously showed the presence of the predicted magnetic resonance at around 100 THz frequencies, equivalent to 3 μm wavelength [4].

We published our experimental results on miniaturized gold SRR arrays, which showed a magnetic resonance at twice the frequency, *i.e.*, at around 200 THz, equivalent to 1.5 μm wavelength [4]. By experiments performed under oblique incidence of light, again loosely speaking, we not only coupled to the SRR via the electric field of light, but also via its magnetic field. Only this coupling can be mapped onto an effectively negative magnetic permeability.

We reached the limit of size scaling by further miniaturized SRRs (see Fig. 6). Thus, the LC frequency should also scale inversely proportional to size.

THORLABS Quantalux™ sCMOS Camera

Thorlabs' Scientific-Grade Cameras are specifically designed for microscopy and other demanding applications.

The new Quantalux™ sCMOS camera is a **low noise, high quantum efficiency**, and **fast frame rate imager** in a compact package

The 2.1 Megapixel Quantalux™ sCMOS Camera is based on a high-performance <1 e⁻ read-noise imager. The monochrome sensor can image the full frame [1920 (H) x 1080 (V)] at 50 fps with 16 Bit resolution and offers a peak quantum efficiency of 61% at 600 nm.



The new
CS2100M-USB



The compact housing of the Quantalux sCMOS camera enables seamless integration into a multitude of setups.

Suggested applications include fluorescence microscopy, VIS/NIR imaging, multispectral imaging, and low-light inspection. To see our full line of Scientific Cameras, please visit thorlabs.com.

Thorlabs sas
78600 Maisons-Laffitte, FRANCE
Tél : +33 (0)974 444 844

www.thorlabs.com

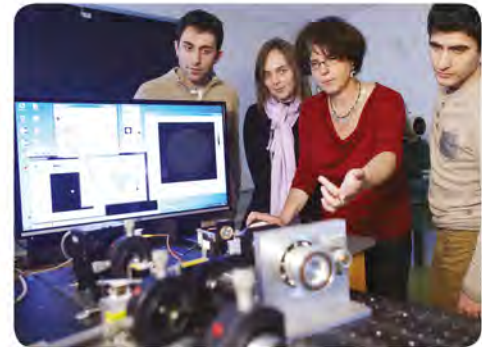

- Infrared, electro-optics
- Instrumentation, components, fabrication
- Optical design
- Imaging, measurement & communication systems
- Sources, lasers, lighting
- Specialized Mastère® *Embedded Lighting Systems*

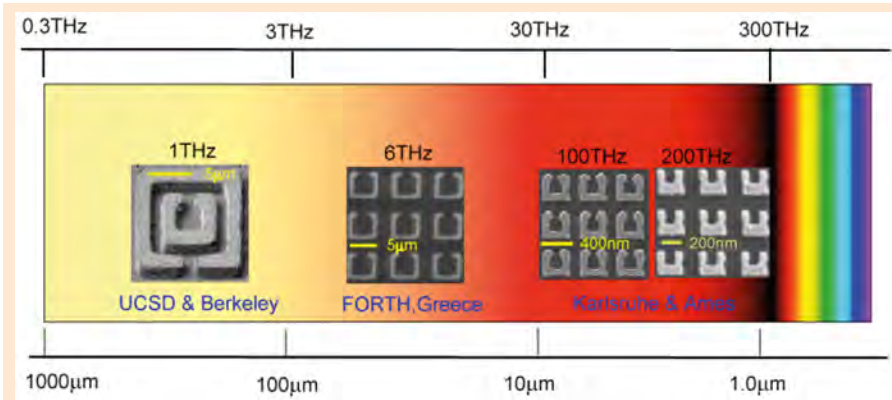

Figure 6. The operation frequency of magnetic metamaterials increased rapidly. The structures operating at 1, 6 and 100 THz frequency, respectively, were fabricated in 2004, and the one at 200 THz in 2005.

It does not though. At frequencies higher than the damping rate, the electrons in the metal develop a 90-degree phase lag with respect to the driving electric field of the light. Our work showed that this limit is reached at around 900 nm eigenwavelength – unfortunately just outside of the visible regime.

Despite of this saturation, reducing the capacitance of the SRR can further increase the frequency. In this fashion, one gets a continuous transition between a traditional SRR and a pair of cut wires [4,5]. Of course, this frequency increase at fixed SRR side length comes with a price: It also means that the ratio of operation wavelength and size of the resonating object decreases significantly,

bringing one close to the edge of validity of describing these structures by using effective material parameters. Nevertheless, our optical experiments and the retrieval of effective parameters suggested the possibility of obtaining a negative magnetic permeability – even under normal incidence of light with respect to the substrate (see Fig. 7).

We also investigated the optical properties of these double-fishnet optical metamaterials under oblique incidence of light and for different polarizations. We found an angular dispersion, which can be interpreted in terms of spatial dispersion due to interaction among the different unit cells (see Fig. 8).

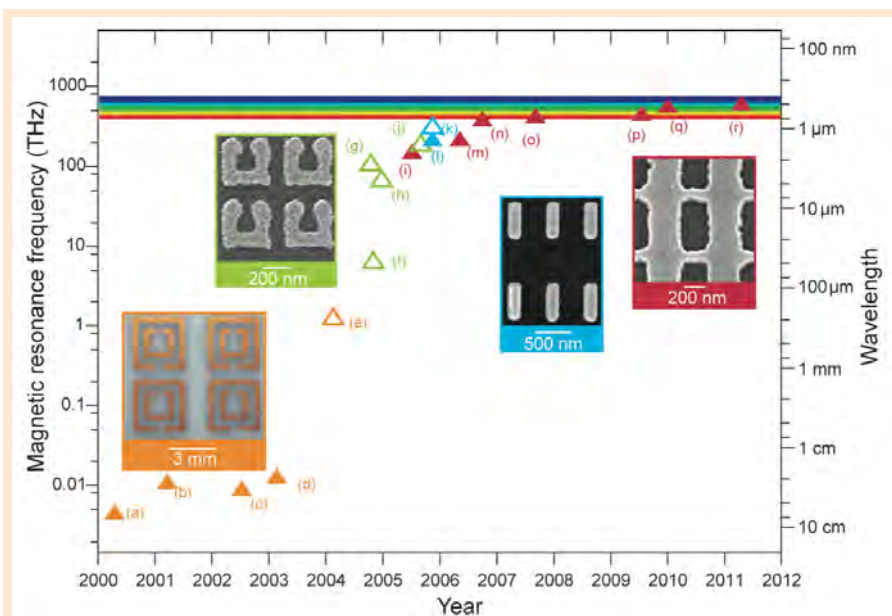

Figure 7. Fabrication progress of negative index materials vs year. This figure is taken from the article in *Nature Photonics* 5, 523 (2011) written by Soukoulis and Wegener [4].

Continuing Education at Institut d'Optique in Optics and Photonics

- In English or French
- In France or abroad
- On catalogue or on demand
- From basics to specialization
- +150 experimental stations
- Expert trainers
- Strong links with industry

ON-LINE CATALOGUE fc.institutoptique.fr





THE LEADING PHOTONICS INDUSTRY ASSOCIATION

EXPLORING MARKETS
EXPANDING APPLICATIONS
CONNECTING PEOPLE

EPIC fosters a vibrant photonics ecosystem by maintaining a strong network and acting as a catalyst and facilitator for technological and commercial advancement. EPIC publishes market and technology reports, organizes technical workshops and B2B roundtables, international delegations, engages in advocacy and lobbying, European funded projects, finance and investment, education and training activities, standards and roadmaps, and pavilions at exhibitions.

www.epic-assoc.com

These structures operating at around 1.5 μm wavelength were based on gold as metal. Soon thereafter, we could reproduce the same effects at comparable wavelength at much lower damping by using silver instead of gold.

Optical metamaterials containing gain media

Our experimental efforts to bring gain media into close proximity of SRR arrays operating around 1.5 μm wavelength to compensate for these losses were motivated by our own early theoretical work suggesting this approach might work. However, our efforts over several years based on using thin semiconductor films as gain media in the near field of the SRR were not successful. The experiments did show some loss reduction, with line shapes in agreement with theory, but the beneficial effects were not large enough at the end of the day. Thus, we eventually gave up working in this direction.

Nevertheless, we studied loss compensation of SRR structures with a gain layer underneath in quite some detail theoretically. Numerical results showed that the gain layer could compensate the losses of the SRR, for light propagating parallel and

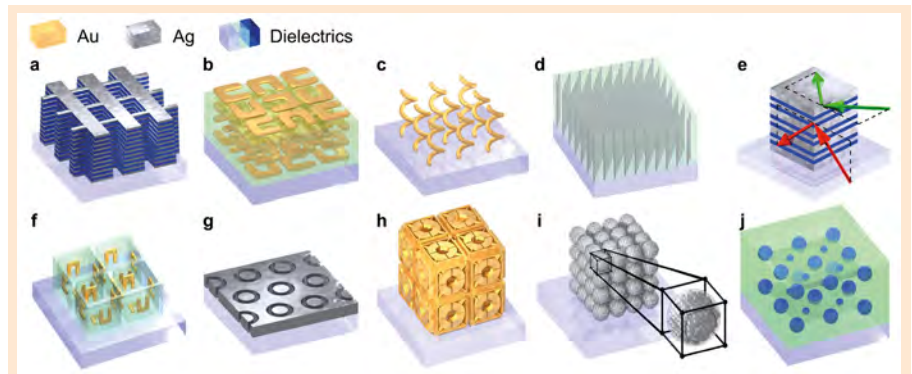

Figure 8. 3D Photonic-Metamaterials Structures. This figure is taken from the article in Nature Photonics 5, 523 (2011) written by Soukoulis and Wegener [4].

perpendicular to the plane of the metamaterial layer. Three different gain pumping schemes were applied in the simulations and the efficiencies of their corresponding loss compensations were studied by investigating the line width of the resonant current. We have also studied the effect of the background dielectric of gain.

We have introduced an approach for pump-probe simulations of metallic metamaterials coupled to gain materials. We study the coupling between the U-shaped SRRs and the gain material described by a four-level gain model. Using pump-probe simulations, we find a distinct behavior for the differential transmittance $\Delta T/T$ of the probe pulse with and without SRRs in both magnitude and sign

(negative, unexpected, and/or positive). Our approach verified that the coupling between the metamaterial resonance and the gain medium is dominated by near-field interactions. Our model can be used to design new pump-probe experiments to compensate for the losses of metamaterials.

Graphene for THz applications

Graphene – a one-atom-thick continuous sheet of carbon atoms – has special properties (e.g., electric and chemical tunability, high kinetic inductivity allowing for strongly confined plasmons, large THz optical conductivity) that make it a desirable material for manipulating terahertz waves.

— SPECTROGON —

State of the art products

Interference filters

- 200 to 15000 nm
- Bandpass
- Longwave-pass
- Shortwave-pass
- Broad-bandpass
- Neutral density
- Web stock items



Holographic gratings

- 150 to 2000 nm
- Pulse compression
- Telecom
- Laser tuning
- Monochromator
- Spectroscopy
- Web stock items



UK: sales.uk@spectrogon.com • Tel +44 1592770000
 Sweden (headquarters): sales.se@spectrogon.com • Tel +46 86382800
 US: sales.us@spectrogon.com • Tel +1 9733311191

www.spectrogon.com

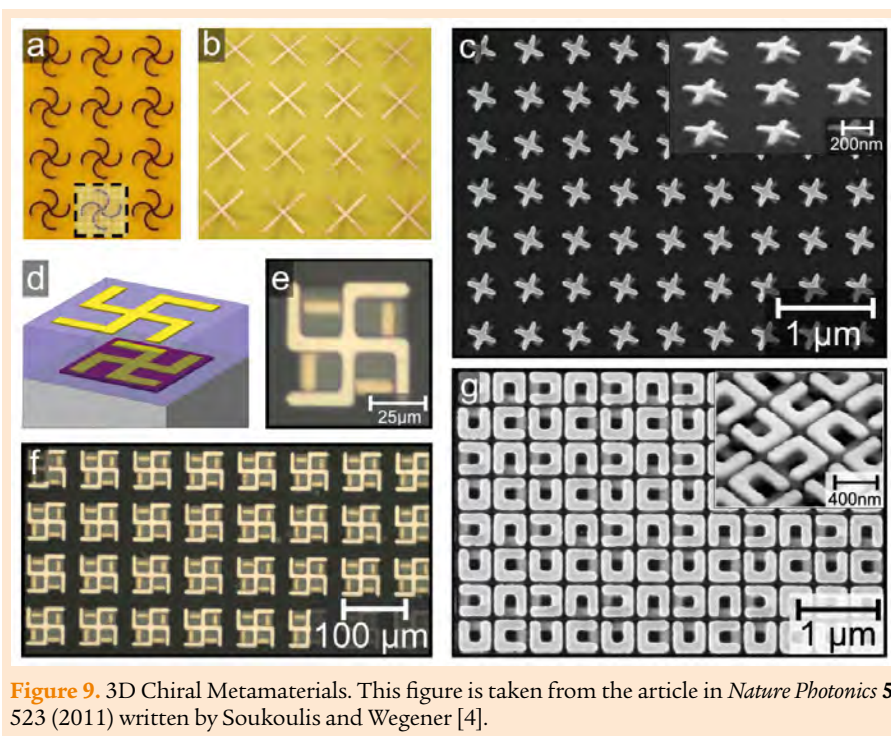

Figure 9. 3D Chiral Metamaterials. This figure is taken from the article in *Nature Photonics* 5, 523 (2011) written by Soukoulis and Wegener [4].

THz applications operate at frequencies between microwave and far infrared. Some metamaterials could benefit by replacing the metals currently used in fabrication with graphene. Graphene also offers the advantage of a potential enhancement of terahertz wave confinement [6] and smaller, more sub-wavelength metamaterial resonators made from graphene rather than metals. However, as we pointed out in our analysis of published experimental measurements of the THz optical conductivity of graphene, the experimental data have shown significantly higher electrical losses at THz frequencies than have been estimated by theoretical work or have been assumed in mostly very optimistic numerical simulations, showing that more research needs to be done to make metamaterial devices from graphene. We also published an analysis and comparison of gold- and graphene-based resonator nanostructures for THz metamaterials and an ultrathin graphene-based modulator. Metamaterial resonators and plasmonic applications have different requirements for what can be considered a good conductor. We published a systematic comparison of graphene, superconductors, and metals as conducting elements in either metamaterials or plasmonics [6].

Chiral optical metamaterials

At this point we reminded ourselves that optical activity and circular dichroism can be explained by using magnetic-dipole resonances excited by the electric-field of the light and vice versa. This fact is related to bi-anisotropy (see Fig. 9).

Our early work in this direction used SRR or variations thereof arranged into single or different layers. These samples were fabricated by using electron-beam lithography of several aligned layers. This led to very large circular birefringence effects at negligible linear birefringence.

Experiments and theory were in good agreement.

Conclusion

3D printing benefits from metamaterials and vice versa. By this combination, printing of thousands of different effective material properties may become accessible by using only a few ingredient material cartridges – in analogy to printing thousands of different colors from just three color cartridges in today's 2D graphical printers.

Today, many fundamental metamaterial effects have been demonstrated experimentally in microwaves, optics, thermodynamics, mechanics, and transport. Most scientifically fascinating to the authors are sign reversals of effective material parameters and the possibility of cloaking in all of these areas. Sign reversal has been shown for the magnetic permeability, refractive index, dynamic mass density, differential mechanical stiffness, thermal length-expansion coefficient, and the Hall coefficient.

Acknowledgements

The work at Ames Laboratory was partially supported by the US Department of Energy (Basic Energy Science, Division of Materials Sciences and Engineering) under Contract No. DE-AC02-07CH11358 Work at FORTH was supported by the European Research Council under the ERC Advanced Grant No. 320081 (PHOTOMETA). ■

FURTHER READING

- [1] J.P. Markos and C.M. Soukoulis, *Wave Propagation: From Electrons to Photonic Crystals and Left-Handed Materials* (Princeton, New Jersey, 2008)
- [2] C.M. Soukoulis, Bending Back Light: The Science of Negative Index Materials. *Opt. and Phot. News*, June 2006, 16 (2006)
- [3] C.M. Soukoulis, M. Kafesaki and E.N. Economou, Negative index materials: New frontiers in optics. *Adv. Mater.* **18**, 1941 (2006)
- [4] C.M. Soukoulis and M. Wegener, Past Achievements and future challenges in the development of 3D photonic metamaterials. *Nature Photon.* **5**, 523 (2011)
- [5] P. Tassin, T. Koschny, M. Kafesaki and C.M. Soukoulis, A comparison of graphene, superconductors and metals as conductors for metamaterials and plasmonics. *Nature Photon.* **6**, 259 (2012)
- [6] P. Tassin, T. Koschny and C.M. Soukoulis, Graphene for terahertz applications. *Science* **341**, 620 (2013)



Advanced expertise and solutions in specialty fibers and modulators for high power fiber lasers

Fiber Lasers are being integrated in an ever-increasing variety of applications: process machines (marking, cutting, welding), LIDAR systems for navigation and high intensity laser (inertial fusion, plasma). Also, their use extends to environments that can be extreme (underwater, radiation, space).

Fiber laser systems operate in continuous or pulsed regime in the 1 to 2 μ m wavelength band. They take advantage of the latest technological advances in fiber Bragg gratings (high power handling, ultra-narrow grating) as well as improvements in double cladding Ytterbium, co-doped Erbium Ytterbium or Thulium doped fibers where iXblue is a leading supplier. For example, iXblue provides a series of large core polarization maintaining fiber for high energy LIDAR at 1.5 μ m (IXF-2CF-EY-PM) featuring a 30 μ m core diameter.

Optical pulse durations on the order of a few tens to hundreds of nanoseconds is typically generated by conventional means (direct modulation). However, recent advances



in processing tools have allowed the use of more complex pulses (pulse shaping) that can be much shorter (a few tens of picoseconds to a few nanoseconds). This requires external modulation capability using electro-optic modulators and is particularly true in the near-infrared (1,000nm). To address this market demand, iXblue has developed a series of ultra-fast amplitude modulators (NIR-MX-LN) featuring very low insertion loss (<3dB) using an iXblue patented design. The modulators are designed to be used with a low control voltage (4V) and provide a wide modulation bandwidth capable of generating <10ps rise and fall time with optical extinction ratios of more than 40dB.

Also, by optimizing the doping properties of the material (Lithium Niobate), iXblue has been able to qualify the near infra-red modulator series for a continuous optical power handling of 300mW. iXblue plans on extending the optical power handling to the Watt level in the near future by using a new fiber to waveguide coupling solution. Also, the near infra-red modulator family has been extended with a new intensity modulator (NIR-DSM) featuring a monolithic integration of two cascaded intensity modulators yielding optical extinction ratios greater than 60dB.

Another point worth mentioning is that the near-infrared phase modulators (NIR-MPX) developed by iXblue are especially well suited for spectral broadening applications and high-power lasers beam combining applications.

Finally, the iXblue product portfolio also includes solutions for extreme environmental constraints such as space or areas subject to ionizing radiation. This is the results of a long development and qualification process for iXblue's modulators, fiber Bragg gratings and active fibers. ■



CONTACT

IXBLUE

Hervé Gouraud

Sales Manager

herve.gouraud@ixblue.com

www.ixblue.com

BUYER'S GUIDE FOR a terahertz (THz) camera

François SIMOENS

CEA-Leti, Minatec Campus, Université
Grenoble Alpes, 17 rue des Martyrs,
38054 Grenoble, France
francois.simoens@cea.fr

Many academic research laboratories use terahertz cameras to characterise sources, align optical tables, study physical phenomena, *etc.* At the same time, more and more applied research teams, in R&D institutes and companies, use these cameras to investigate the applications of terahertz imaging in varied domains such as security, non-destructive testing, or environment and health issues. In response to these needs, mature uncooled terahertz cameras are now being commercialized.

The terahertz domain is not specifically defined over the electromagnetic spectrum: it extends from roughly 100-300 GHz to roughly ten terahertz (1 terahertz (THz) = 1000 gigahertz (GHz)), partially covering the millimetre and sub-millimetre bands, down to the infrared (IR) region. This corresponds to wavelengths of a few tens of micrometres up to a few millimetres.

This radiation exhibits some unique properties: it penetrates numerous non-metallic and non-polar materials (such as paper, cardboard, textiles, plastics and ceramics), many interesting molecules feature specific spectral signatures that often do not exist on other parts of the electromagnetic spectrum, such as near- and mid-infrared, and finally it does not have any ionising effects and is considered as biologically innocuous (1 THz = 4.1 meV, which is a million times weaker than X photons).

These properties open new horizons in applications like medicine, biology

and pharmacy (since terahertz waves do not alter DNA), domestic security (to check what people are carrying or the content of packages) or even non-destructive testing of manufactured products (for example, to detect defects in shape, contaminants and delaminations).

THz imaging will enable applications that need to “look inside” conventionally opaque materials that are transparent in this electromagnetic range, or to determine the chemical composition of samples by **spectral analysis**. In many cases, these two approaches could even be combined: multispectral or hyperspectral THz imaging would enable to simultaneously locate and identify the chemical nature of elements in an image.

The commercial spread of THz applications is conditional on the emergence of advanced technologies combining low cost and small size. These components are becoming available commercially, in particular the uncooled video¹ 2D-array THz cameras described in this article.



Figure 1. Examples of THz images (taken with CEA-Leti sensors). (a) Leaf in transmission. (b) Visible image of objects concealed on the chest. (c) Raw THz image of objects concealed under a shirt.

¹ ‘1D cameras’, such as the Traycer T-Wave 1D, are also available commercially. It should also be noted that the Japanese company NEC has decided to stop manufacturing its bolometer-based THz cameras after several years of production.

Active imaging and passive imaging

There are two THz imaging methods. Passive imaging uses thermal radiation emitted by an object at non-zero temperature, whereas active imaging requires an external THz source. The low thermal power generated in the THz range requires the use of sensors with very high sensitivities (typically with a noise equivalent power (NEP) in the range of few $\text{fW}/\sqrt{\text{Hz}}$) that only cryogenic or heterodyne sensors can reach. The manufacturing and operating costs, as well as the size of these systems, limit them to applications such as defence, space and security.

Uncooled THz cameras can overcome these 'market' barriers, but in return, they require the use of external sources of illumination. Currently, at the same time as an increase in commercial sources, a dozen or so uncooled cameras are now available commercially (cf. table at the end of the article).

Main technologies used in uncooled cameras

Two main transduction phenomena are used in existing cameras.

(1) Thermal sensors convert optical radiation into heat at the level of each pixel. This local temperature change is in turn results in the variation of a physical property of the pixel, its electrical resistance (resistive bolometer) or its surface charge (pyroelectric effect).

The bolometric sensors of INO cameras have a micro-bridge structure very similar to that of standard IR sensors; absorption in the THz range is optimised by modifying the equivalent impedance of the absorber, either by coating it in extremely porous black gold or adding frequency selective surfaces (FSS) on the membrane.

In comparison to standard bolometers, the ones developed at Leti (integrated as detectors of the i2S TZCAM camera) are groundbreaking insofar as they separate the optical collection and thermometry



Figure 2. i2S TZCAM camera integrating the technology of CEA-Leti bolometric 320×240 matrix sensors and an $f/0.8$ lens.

functions. These two functions can therefore be optimised independently. Optical absorption is provided by the antennae located under and on the micro-bridge in conjunction with a resonant cavity between the antennae plane and the CMOS readout circuit. The heating of the antennae loads generated by the surface currents is then converted by a thermoresistive layer placed on the micro-bridge.

The Ophir Pyrocam camera features a matrix of 160×160 LiTaO_3 pyroelectric pixels connected by indium balls to a multiplexing readout circuit. This camera also includes a mechanical chopper, required in this type of thermal sensor due to its sensitivity to current variations.

Another THz thermal camera (NeTHIS OpenView) firstly uses a membrane to convert THz photons into heat and then images the infrared (IR) emissions of this membrane using a commercial IR camera.

(2) Sensors based on electro-optical rectification in the channel of a field effect transistor (FET). In order to optimise the optical coupling of THz radiation, antennae are connected to two FET ports (e.g. gate and source) and a truncated hemispheric lens is placed above the antenna plane.

Main shared features of these cameras

Being quadratic, these sensors only provide information on the amplitude of the THz signal².

We are there
when innovation
leads to an edge.

Our silicon photomultipliers are highly sensitive, small and fast. They are ideal as a replacement for conventional photomultipliers with an electron tube.

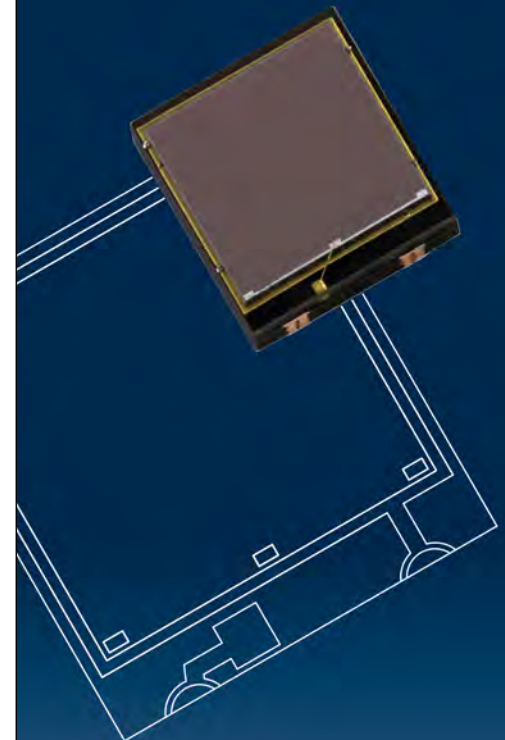

² Coherent THz sensors do exist but not, to date, in the matrix format used in commercial cameras.

With the exception of OpenView, Pyrocam III and Terasense, all of these cameras are based on direct detection by a monolithic sensor incorporating both the pixel matrix and the CMOS ASIC circuit³; this circuit provides the functions of multiplexing, filtering, amplification and video formatting of signals detected by each pixel.

The FET-based sensors of the Tic-Wave camera are processed directly in the CMOS silicon (Si) wafers, whereas the bolometer matrices of the INO and i2S-Leti cameras are produced collectively above the CMOS substrates according to standard microelectronic Si processes. This specificity provides miniature sensors and electronic processing in ASIC CMOS as close as possible to the pixels. It also offers opportunities for significant reductions in production costs if the volume of cameras sold were to increase.

Finally, it should be noted that only the two bolometric cameras mentioned are equipped with lenses with numerical apertures between 0.7 and 0.9 and focal lengths of a few tens of millimetres.

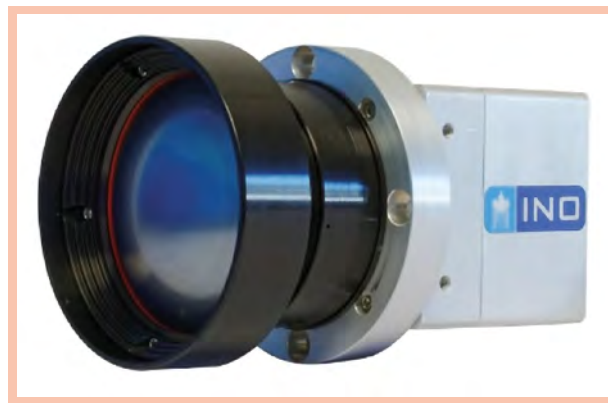

Figure 3. The INO MICROXCAM-384i-THz camera with integrated bolometric matrix sensor and equipped with its lens.

Criteria for choosing a terahertz camera

When an imaging system is designed, an initial sizing of the system can provide an assessment of the incident optical flux on the image plane, of the optimum operating frequency range, of the maximum possible video rate and of the spatial coverage.

In light of this system analysis, the first criterion to consider when choosing a camera is its detection threshold in the chosen spectral operating range. This is often the critical feasibility milestone to overcome, given the low level

of optical power delivered by commercial THz sources (a few hundred mW at most in continuous mode with gas or quantum cascade lasers) and the heavy attenuation of radiation that occurs during propagation in atmosphere and through various obstacles and optical dioptries.

In order to compare cameras, this per-pixel sensitivity threshold should be calculated using the measurement of signals delivered by the matrix camera in video mode. It should be acknowledged that this setting is often unknown or misleading⁴. In particular, spectral absorption curves are

BRAND	PRODUCTS	INFO	CONTACT
i2S Vision	TZCAM camera with an f/0.8 20 mm lens, incorporating a 320×240 microbolometer matrix sensor (50 µm pitch, 25 Hz, CEA-Leti technology)	http://www.i2s.fr/project/camera-terahertz-tzcam/	Alexandre Besson Tel. +33(0)6 71 22 14 53 a.besson@i2s.fr
INO	MICROXCAM-384i-THz camera with 2 possible lenses (44 mm f#0.7 & f#0.95) and a 384×288-pixel bolometric sensor (35 µm pitch, 50 Hz)	http://www.ino.ca/en/products/terahertz-camera-microxca-384i-thz/	Pierre Talbot Tel. +1 (418) 657-70-06 pierre.talbot@ino.ca
NeTHIS	OpenView conversion membrane-based THz-IR camera combined with a commercial IR camera (256×320, 170 µm pitch / 512×640, 80 µm pitch)	http://nethis-thz.com/index.php/openview/	Jean-Pascal Caumes Tel. +33(0)6 47 16 93 22 / +33(0)5 47 74 62 10 jean-pascal.caumes@nethis-thz.com
TeraSense	GaAs FET IMPATT-based Tera camera (3 models: 16×16 / 32×32 / 64×64, pitch = 1.5 mm)	http://terasense.com/products/sub-thz-imaging-cameras/	Tel. +1 (408) 600-14-59 info@terasense.com
Tic-Wave	TicMOS-1px FET CMOS-based camera (up to 500 fps, 100×100 pixels)	http://ticwave.com/products.html	contact@ticwave.com
Newport/Ophir	Pyrocam IV camera based on a 320×240 pyroelectric sensor (pitch = 80 µm)	http://www.ophiropt.com	Nicolas Chaise, OPHIR Spiricon Tel. +33(0)1 60 91 68 23 / +33(0)6 01 01 27 32 nicolas.chaise@eu.ophiropt.com Ariane Billard, Newport Corporation Tel. +33(0)1.60.91.68.68 ariane.billard@newport.com

³ ASIC: application-specific integrated circuit.

⁴ For example, it is often difficult to know whether one of the settings has been calculated rather than measured, whether averaging has been used, the level of response from which pixels are considered functional, etc.



Research takes time.

Ordering your lab equipment shouldn't.

Thousands of products now in stock and
FREE 2-DAY Shipping*

Outfitting your lab or research facility shouldn't be a time-consuming process. At MKS, we get it. That's why we're significantly increasing stock, introducing a new streamlined online shopping experience for you and offering **FREE 2-day shipping***. Buying Newport products for your lab just got a whole lot easier and faster.

- Faster SELECTION** – find it fast with enhanced search and filtering
- Faster DELIVERY** – FREE 2-day shipping* on all your favorite Newport products
- Faster RESULTS** – succeed with top quality products and support

Get up and running fast with Newport. There's no time to waste.
Check us out today at www.newport.com

* For more details and restrictions visit www.newport.com/free2day
Applies to orders placed and shipped in North America and Europe only



For more information about our Newport Brand visit
www.newport.com



Faster Selection Faster Delivery Faster Results

rarely given for the displayed frequency range, which is often very broad.

The sensitivity criteria can be defined by the minimum detected power (MDP, expressed in watts) at a given image frequency. The MDP is defined as the relationship between the RMS noise measured at the output of the camera (in V_{rms}) and the average pixel response (expressed in V/W)⁵.

Bolometric cameras are the most sensitive, with MDPs in the range of a few dozen pW on peak absorption frequencies (a few THz), whereas the MDPs of FET-based cameras come close to dozens of nW (9 nW measured at 0.9 THz by the University of Wuppertal, which developed the Tic-Wave camera). The NeTHIS thermo-conversion membrane-based camera and the Pyrocam III camera have an MDP of around ten μW , but in return boast a very broad IR to THz response spectrum.

Spatial resolution and total acquisition period are often key specifications

for the intended application. Preference should be given to the most sensitive sensors, but also the largest formats and fastest frame rates. Microbolometer-based cameras are the largest, typically a quarter of VGA, but they also have reduced pixel footprints (a few dozen micrometres). FET-based cameras are smaller, but have larger pixel footprints and are therefore more suitable for the spectral range, around 100 GHz. The frame rates of commercial cameras are all close to standard usual video frequencies.

Finally, cost is obviously a decision-making determinant, as well as the choice of THz sources and opto-mechanical systems that may be required. But in light of often very critical radiometric reports, this selection criterion is of secondary importance compared to those described above. We have yet to find the 'killer application' for this type of camera to take off and bring about more affordable prices, which the currently used technological approaches should allow. ■

FURTHER READING

- [1] N. Oda *et al.*, *J. Infrared Milli. Terahz. Waves* **35**, 671 (2014)
- [2] H. Sherry *et al.*, in ISSCC 2012 (IEEE), <https://doi.org/10.1109/ISSCC.2012.6176997>
- [3] M. Bolduc *et al.*, *Proc. SPIE* **8023**, 80230C (2011)
- [4] F. Simoens and J. Meilhan, *Phil. Trans. R. Soc. A* (2014)

⁵ Four organisations developing these cameras, NEC [1], Tic-Wave [2], INO [3] and Leti [4], have determined the sensitivity of their matrix sensors based on this setting, allowing for comparisons with minimal assumptions and uncertainties.

OUR SELECTION OF NEW PRODUCTS

Handheld spectrometers



The PG100N allows light measurement with fully NIST-traceable performance. Through an integrated, high resolution color display, parameters such as LUX, CCT, chromaticity, CRI and SPD can be viewed instantaneously or monitored over time. The CMOS linear image sensor is effective from 380 nm in the UVA to 780 nm in the near-infrared. In addition to internal data logging, downloads via SD card, USB port or Wi-Fi mode allow data tracking and analysis with download capability in Excel and JPG formats.

www.gamma-sci.com

Micropolarizer cameras

The PolarCam snapshot micropolarizer camera simultaneously captures four polarization states in each video frame, enabling a range of image enhancement techniques and polarimetric measurements. CMOS technology sensors enable up to 164 frames/second imaging rate at 1700x1200 pixel resolution.

A high resolution model captures 3.8 MP frames for detailed analysis of polarization even in fast-changing scenes. Customizable regions of interest make it possible to process a subset of the acquired pixels, resulting in frame rates in the kilohertz range.

www.4dtechnology.com/polarcam



Fiber laser processing head

The FLBK40 is a light weight, compact modular beam delivery system. Four different focal length collimators with QB connectors, to ensure that the head can be matched to the output characteristics of virtually any fiber laser. Six different sets of focusing optics (four for welding and two for cutting) enable focusing at a number of different spot size and working distance combinations. The integrated IR illumination and camera options guarantee good visibility of the work surface.

www.coherent.com



Optical mounts

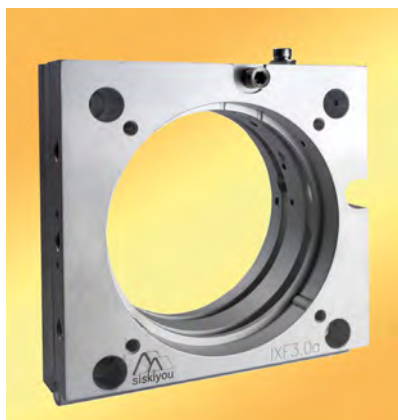

Siskiyou Corporation has expanded their IXF series of monolithic flexure optical mounts to include larger models that can accommodate 3" (75 mm) and 4" (101 mm) diameter optics. These mounts utilize a unique configuration in which all parts (including the springs) are fabricated from a single piece of metal (steel and aluminum versions). This mechanism is specifically designed to securely retain high flatness components (e.g., optics with a flatness of $\lambda/10$ or better) without noticeably degrading their wavefront performance.

www.siskiyou.com

Broadband light source

The Mighty Light Plus (ML+) from Spectrolight is a high power white light source for microscopy, white light interferometry, machine vision, and precision inspection applications. The ML+ outputs up to 7 W from a 10 mm diameter, detachable, armored light guide. This provides high spatial uniformity suitable for both wide-field and focused spot illumination applications. The ML+ bulb temperature of 3400 K delivers output as short as 350 nm, while producing useful power above 2.5 μm .



www.spectrolightinc.com

NanoRaman



After four years of successful cooperation with AIST-NT, HORIBA Scientific, global leader in Raman spectroscopy for over 50 years, announced the acquisition of AIST-NT technology, provider of innovative integrated scanning probe systems. This technology will strengthen HORIBA's leadership in NanoRaman by combining the most advanced SPM for optics with HORIBA's cutting-edge Raman technology.

www.horiba.com/nanoraman



Instrumentation de test optique



Mesure de la plupart des paramètres optiques

FTM, EFL, BFL, centrage, alignement front d'onde

Applications en R&D et production



Banc de FTM UV, VIS, IR

Interféromètre "µPhase"

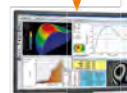

Station de centrage optique



Trioptics France

76 rue d'Alsace
69100 Villeurbanne
Tel. 07 72 44 02 03
Fax : 04 72 44 05 06
www.trioptics.fr

Photoniques is published by EDP Sciences,
17 avenue du Hoggar,
P.A. de Courtabœuf,
91944 Les Ulis Cedex A, France
Phone: +33 (0)1 69 18 75 75
Fax: +33 (0)1 69 07 45 17
RCS: 308 392 687
ISSN: 1629-4475 – e-ISSN: 2269-8418
www.photoniques.com
www.edpsciences.org



Photoniques is the magazine
of the French Optical Society
2 avenue Augustin Fresnel
91127 Palaiseau Cedex, France

mariam.mellot@institutoptique.fr
Phone: +33 (0)1 64 53 31 82
Fax: +33 (0)1 64 53 31 84

Director of publishing Jean-Marc Quilbé
Phone: +33 (0)1 69 18 75 75

Editorial staff

Chief Editor Riad Haidar,
Cellphone: +33 (0)6 85 04 78 52
riad.haidar@edpsciences.org

Production Editor Vincent Colpin
vincent.colpin@edpsciences.org

Layout Studio wake up!
www.studiowakeup.com

Editorial Board

Pierre Baudoz (Observatoire de Paris),
Nicolas Bonod (Institut Fresnel, Marseille),
Azzedine Boudrioua (Institut Galilée, Paris 13),
Émilie Colin (Quantel),
Céline Fiorini-Debuisschert (CEA),
Wolfgang Knapp (Club laser et procédés),
Patrice Le Boudec (IDIL Fibres Optiques),
Christian Merry (Laser Components),
François Piuze (CEA),
Marie-Claire Schanne-Klein (École polytechnique),
Christophe Simon-Boisson (Thales Optronique),
Costel Subran (F2S - Fédération des Sociétés Scientifiques),
Ivan Testart (AFOP).

Advertising Annie Keller
Cellphone: +33 (0)6 74 89 11 47
Phone/Fax: +33 (0)1 69 28 33 69
annie.keller@edpsciences.org

Subscriptions

Photoniques - EDP Sciences
17 avenue du Hoggar
PA de Courtabœuf
BP 112 - 91944 Les Ulis cedex A
subscribers@edpsciences.org

Printer Imprimerie de Champagne
Rue de l'Etoile de Langres
ZI Les Franchises - 52200 Langres

Legal deposit Avril 2018

Route STAMP (95)



NEW PRODUCTS

Adaptive optics

ALPAO reviewed its deformable mirrors, wavefront sensor and adaptive optics systems to fit applications from cost effective to state-of-the-art products. 5 new deformable mirrors (DM) feature large stroke, high dynamic motion and optical quality for fast and accurate wavefront corrections. 3 new deformable mirrors (DMX) feature large pitch while maintaining the standard technology features. The large pupil area fits high power laser applications. 7 new Shack-Hartmann wavefront sensors (SH-WFS) are specifically designed for AO; sensitivity, speed and spectral range can be chosen depending on the application.



DM 97-15



SH-WFS



ACE fast

www.alpao.com

Low scatter mirrors

Edmund Optics introduces TECHSPEC low scatter off-axis parabolic (OAP) mirrors. Providing a surface figure of $\lambda/8$ RMS and a surface roughness of less than 50 Å RMS, these precision mirrors are designed for low scatter in the visible spectrum. They precisely direct and focus incident collimated light at a specific angle, resulting in minimal scatter loss. Designed using a proprietary process that decreases scatter in the UV and visible region, each low scatter off-axis parabolic mirror undergoes a visual inspection with a HeNe laser to ensure low scatter.

www.edmundoptics.com

Acousto-optic modulator

Gooch and Housego presents the 397 nm Fiber-Q, a fiber coupled acousto-optic device. Specific TeO₂ crystal is grown in-house and is associated to a pure silica core fiber; as a result this system which is operating at 200 MHz, can accept power levels of up to 100 mW. The device could be installed into the forthcoming generation of quantum computers such as NQIT's Q20:20 Quantum Computer Demonstrator.

www.goochandhousego.com



ADVERTISER INDEX

Aerotech	45	National Laser	18
Alphanov	41	Newport	61
Ardop Industrie	29	Optatech	23
CEA Cesta	17	Optique Fichou	37
CIOE China Intl. Optoelectronic Exposition	12	Optitec	9
Coherent	38	Phasics	19
Edmund Optics	33	Physik Instrumente	51
EPIC	26, 54	Quantel-Keopsys	47
First Sensor	59	Silios	24
HGH Infrared Systems	27	Spectrogon	55
Horiba Jobin Yvon	40	Spectros Optical Systems	16
HTDS	25	Symétrie	21
Idil Fibres Optiques	cover page 4	Thorlabs	52
IDS Imaging	43	Trioptics	63
Imagine Optic	39	University Bourgogne Franche- Comté	49
Institut d'Optique Graduate School	11, 53	Université de Lille 1	35
iXblue	31, 57	Yokogawa	44
Kerdry	13	Zurich Instruments	15
Laser Components	cover page 2		

1064 nm laser

Redfern Integrated Optics, Inc. (RIO) announced its first PLANEX laser emitting the classic YAG wavelength of 1064 nm, featuring narrow line width (15 kHz), low noise and high coherence length. RIO's proprietary PLANEX technology is a combination of a gain chip and a planar light wave circuit (PLC) with an integrated Bragg grating. The combination of these components forms a cavity with up to 20 mW output power, low phase noise as well as very low wavelength sensitivity to bias current and temperature. RIO lasers are available at Laser Components in Germany and in the UK.

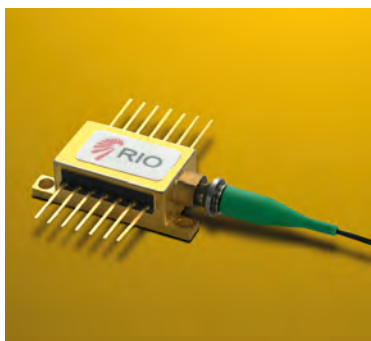

www.lasercomponents.com

Optical spectrum analyser

Yokogawa, the market leader of premium optical spectrum analysers (OSAs), has for the first time released a cost-effective instrument optimised for testing telecom devices during and after production. The new AQ6360 is a benchtop OSA and features very high measurement speed, a compact and robust design and low capital and operational costs.

www.yokogawa.com



CROSSWORDS: FAMOUS OPTICIANS

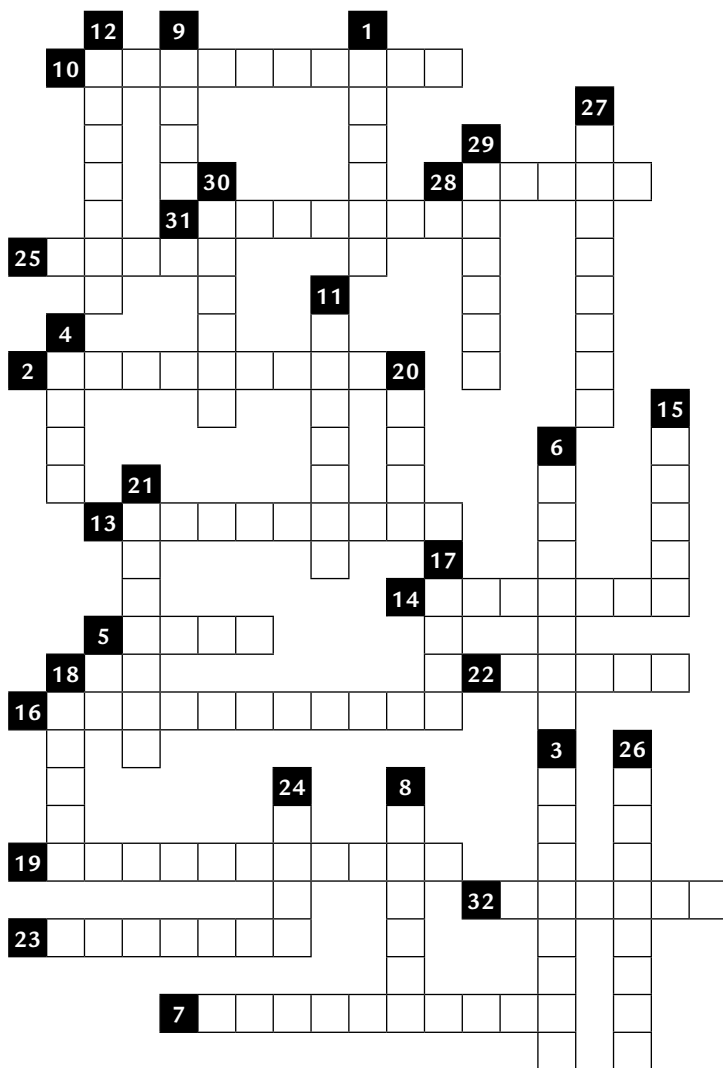

- 1 Least time principle of ...
- 2 Polarization prism of ...
- 3 Elastic scattering of ...
- 4 Extinction anomaly of ...
- 5 Focal phase shift of ...
- 6 Matter wave of ...
- 7 Inequality of ...
- 8 Interferometric rings of ...
- 9 Sine condition of ...
- 10 Wire diffraction grating of ...
- 11 Spot of ...
- 12 Near-field diffraction of ...
- 13 Electromagnetic propagation equation of ...
- 14 Radiometric law of ...
- 15 Interferometric fringes of ...
- 16 Relations of ...-... for energy conservation
- 17 Condensate of ...
- 18 Polarimetric law of ...
- 19 ...'s cat
- 20 Birefringent filter of ...
- 21 Wavelets of ...
- 22 Delta function of ...
- 23 Cage of ...
- 24 Disk of ...
- 25 Statistics of ...
- 26 Power vector of ...
- 27 Angle of ...
- 28 Electrically-induced spectral effect of ...
- 29 Spectral shift of ...
- 30 Wedge interferometer of ...
- 31 Knife edge of ...
- 32 Radiation law of ...



SEE SOLUTION
ON OUR WEBSITE
WWW.PHOTONIQUES.COM



LASERS & OPTICAL FIBERS TECHNOLOGIES



SYSTEMS & COMPONENTS

FOR SCIENCE, INDUSTRY, DEFENCE & EDUCATION



FIBER OPTICS & COMPONENTS



LASERS & AMPLIFIERS



OPTOELECTRONIC SYSTEMS



FIBER SENSORS



SPECTROSCOPY & MICROSCOPY



EDUCATION SYSTEMS